



**GUIDELINES ON
GREENERY PROVISION
AND TREE CONSERVATION
FOR DEVELOPMENTS**

Guidelines on Greenery Provision and Tree Conservation for Developments Version 4

Published by:

Greenery & Development Planning

National Parks Board

ALL RIGHTS RESERVED

© 2023 National Parks Board

No part of this publication may be reproduced in any form: electronic or otherwise, without the written permission from the publisher or author.

National Parks Board (NParks) guidelines will be updated periodically at any time and such changes may take effect immediately. You should therefore try not to print out any page from this Handbook. Check the Handbook regularly to ensure that you are following the most current version.

SUMMARY OF CONTENTS

1 Introduction

2 Conservation of Trees/Plants

3 Greenery Provision within Premises

4 Greenery Provision for Roadside

5 Planting Specifications of Trees/Palms/Shrubs/Hedges/Turf

6 Open Space for Landed Housing Developments

7 Certificate of Statutory Completion (CSC)

8 Submission Procedures

9 Self-Declaration Scheme

10 Appendices

CONTENTS

1	Introduction	8
	Singapore's City in Nature	8
	Greenery & Development Planning	9
2	Conservation of Trees/Plants	11
	Tree Conservation Area (TCA)	11
	Vacant Land	14
	Roadside Greenery	14
	Heritage Roads	15
	Heritage Trees	22
	Technical Requirements on Tree Conservation	22
	Certified Arborist	29
3	Greenery Provision within Premises	44
	Requirements on Greenery Provision within Premises	44
	Planting Provision Abutting/Adjacent Internal Driveways	63
	Planting Provision for Open Air Parking Area at Street Level	64
	Hedges Plantings for Proposed Bin Centre and Electrical Substation within Development Premises	77
	Hedges Planting for Government Schools	78
	Planting Scheme at Building Plan Stage	78
4	Greenery Provision for Roadside	79
	Technical Requirements for Roadside Greenery Provision	79
	Soil Specifications of Green Verges	86
	Road Infrastructures	95
5	Planting Specifications of Trees/Palms/ Shrubs/Hedges/Turf	111
	Trees and Palms	111
	Staking	113
	Tree Collar Protector	116
	Mulching	116
	Shrubs and Hedges Planting	117
	Turfing	118

6	Open Space for Landed Housing Developments	119
	Introduction	119
	Provision for Open Space	119
	Vesting of Open Space	119
	Location of the Open Space	120
	Accessibility of Open Space	120
	Terrain of Open Space	121
	Provision for Drainage	121
	Playground/Fitness Equipment and Space	122
	Footpath	125
	Park Furniture	126
	Signboards	126
	Signage	132
	Benches	133
	Litter Bins	133
	Shelter	134
	Safety Railings	135
	Park Lighting and Over Ground (OG) Box	135
	Soft Landscape and Tree Planting	138
7	Certificate of Statutory Completion (CSC)	139
	Introduction	139
	NParks CSC Approval	139
	CSC Inspection	140
	Acceptable and Unacceptable Horticulture Standards	143
8	Submission Procedures	150
	Building Works Not Requiring NParks' Approval at the Development Control and Certificate of Statutory Completion stages	150
	Pre-Submission Consultation	152
	Non-Compliance Application	152
	Application for Development Control Approval	153
	Application for Building Plan Approval	165
9	Self-Declaration Scheme	178
	Qualifying Developments	178
	Submission Procedures	178
	Submission Requirements	179
	Rejection of Application	180
	Application for DC Approval	181
	Application for BP for Internal Work Approval	187
	Application for BP for External Work Approval	192
	Application for CSC Approval	196
10	Appendices	197
	Appendix A: CAD Drawing Guidelines	197
	Appendix B: Specified Developments Exempted from the Provision of Green Buffers and Peripheral Planting Verges	201

This document tracks the revisions to NParks' guidelines, effective from 30 January 2023.

Chapter No	Chapter Title	Revision to NParks' Guidelines
3	Greenery Provision within Premises	<ul style="list-style-type: none"> • Removal of multi-storey carpark from green buffer requirements boundaries fronting roads • Clarification on the length of encroachment for allowable structure (s) within planting areas • Removal of grass paver requirement for open air parking areas at street level • Update to planting scheme submission under NParks' streamlined application process
4	Greenery Provision for Roadside	<ul style="list-style-type: none"> • Replacement of the term "fire engine hardstanding" areas with "fire engine accessway" • Update to the specifications for Approved Soil Mixture (ASM) • Update to the Pedestrian Overhead Bridge trough soil specifications
5	Planting Specifications of Trees/Palms/Shrubs/Hedges/Turf	<ul style="list-style-type: none"> • Inclusion of establishment period for newly planted trees/palms • Update to staking requirement • Indication of turf species required for reinstatement
6	Open Space for Landed Housing Development	<ul style="list-style-type: none"> • Removal of NParks hotline from examples of NParks signs
8	Submission Procedures	<ul style="list-style-type: none"> • Rearrangement of submission procedure stages • New section on <i>Building Works Not Requiring NParks' Approval at Development Control and Certificate of Statutory Completion stages</i> • Removal of grass paver requirements for open air parking areas at street level • New section on streamlined application process • Inclusion of developments affecting shrubs and ornamental plants under development projects requiring DC Approval
9	Self Declaration Scheme	<ul style="list-style-type: none"> • Removal of grass paver requirements for open air parking areas at street level



1 Introduction

1 INTRODUCTION

Singapore's City in Nature

Singapore's Garden City journey began in 1963 when then Prime Minister Lee Kuan Yew planted a Mempat tree (*Cratoxylum formosum*), signifying the start of the greening campaign. Through the dedication and commitment of our pioneers and the community, the city's landscape has been transformed to one where greenery is a major feature.

Trees are planted extensively along our roads to provide shade, as well as to beautify and enhance the environment. Tiered plantings and flowering species are also introduced to make our roadside greenery more vibrant and to attract more biodiversity to our urban environment. Within and around developments, green spaces are also set aside for planting up lushly with trees and shrubs in order to soften the harshness of high-rise buildings and to provide visual relief in the built environment.

To achieve the vision of a City in Nature, National Parks Board (NParks) works closely with developers, building owners, Qualified Persons (QPs), professionals and other public agencies. This handbook seeks to provide a guide on the statutory and technical requirements for conserving trees, safeguarding green spaces and implementing lush landscaping as part of development projects. The handbook also seeks to inform QPs on the procedures for submitting development plans to NParks for approval.



111 Sun Plaza Park

Greenery & Development Planning

Greenery & Development Planning Branch is a centralised team in NParks that handles Development Control (DC), Building Plan (BP) and Certificate of Statutory Completion (CSC) applications submitted by QPs. We also work with public agencies during the planning and design stages for public sector developments, such as road, rail, drainage and other services projects. Our roles include assessment of development plans to ensure that adequate greenery is provided and that mature trees are not felled unnecessarily.



CHAPTER

- 2 Conservation of Trees/Plants
- 3 Greenery Provision within Premises
- 4 Greenery Provision for Roadside

2 CONSERVATION OF TREES/PLANTS

Tree Conservation Area

Two green spaces in the South Central and Eastern parts of Singapore were gazetted as Tree Conservation Areas (TCAs) on 2 August 1991. This is to control indiscriminate felling of mature trees. These areas were selected for conservation for our future generations to enjoy the vast extent of greenery and natural heritage. The mature trees in the TCA, some of which are 50 to 100 years old, help to beautify our environment with their lush foliage and shaded canopies.

Developers and private property owners who wish to fell any mature tree with a girth of more than 1.0m, that measures at 1.0m from the ground and grows on a designated TCA, have to seek written approval from the Commissioner of Parks & Recreation. This is required even if no development works are in progress on-site.

Overview of TCAs

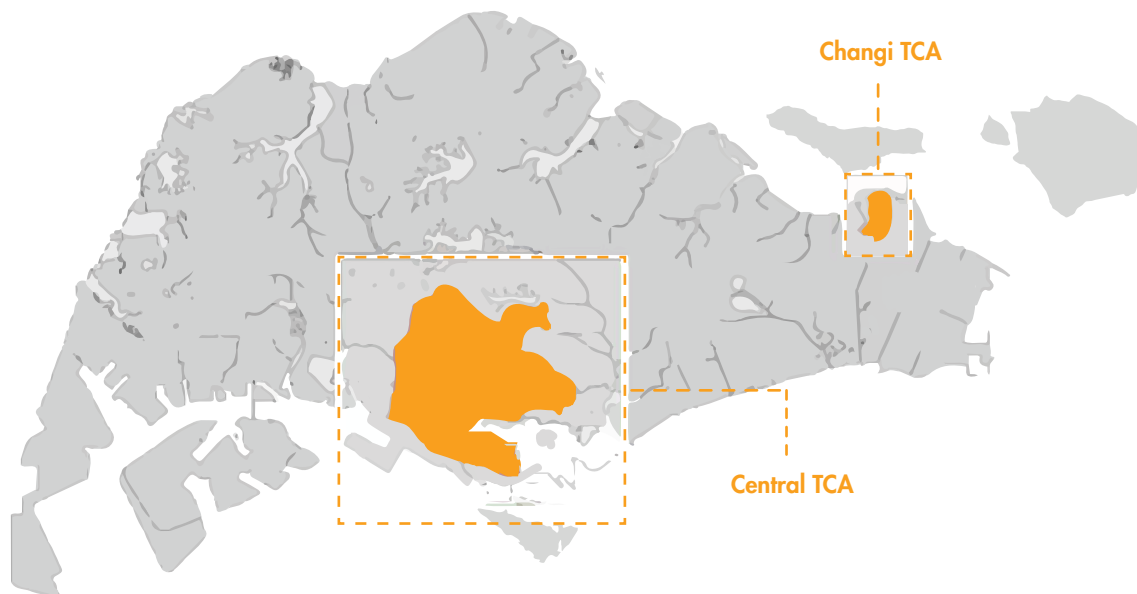

The two TCAs are:

Central TCA

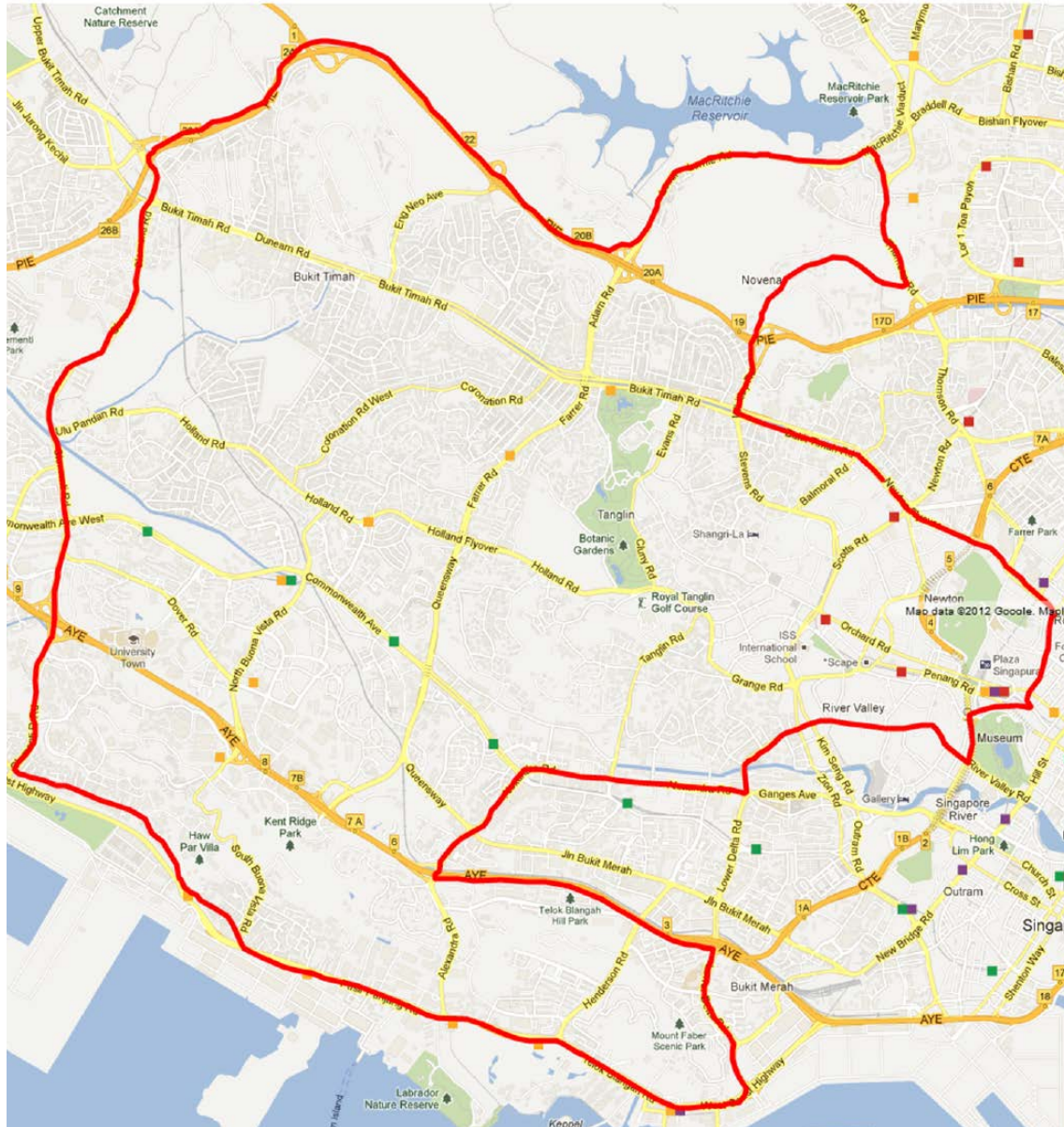

Central TCA – Bounded by the Pan Island Expressway, Clementi Road, Pasir Panjang Road, Telok Blangah Road, Kampong Bahru Road, Lower Delta Road, Ayer Rajah Expressway, Alexandra Road, River Valley Road, Clemenceau Avenue, Fort Canning Road, Orchard Road, Prinsep Street, Selegie Road, Dunearn Road, Whitley Road, Mount Pleasant Road, Thomson Road and Lornie Road.

Changi TCA

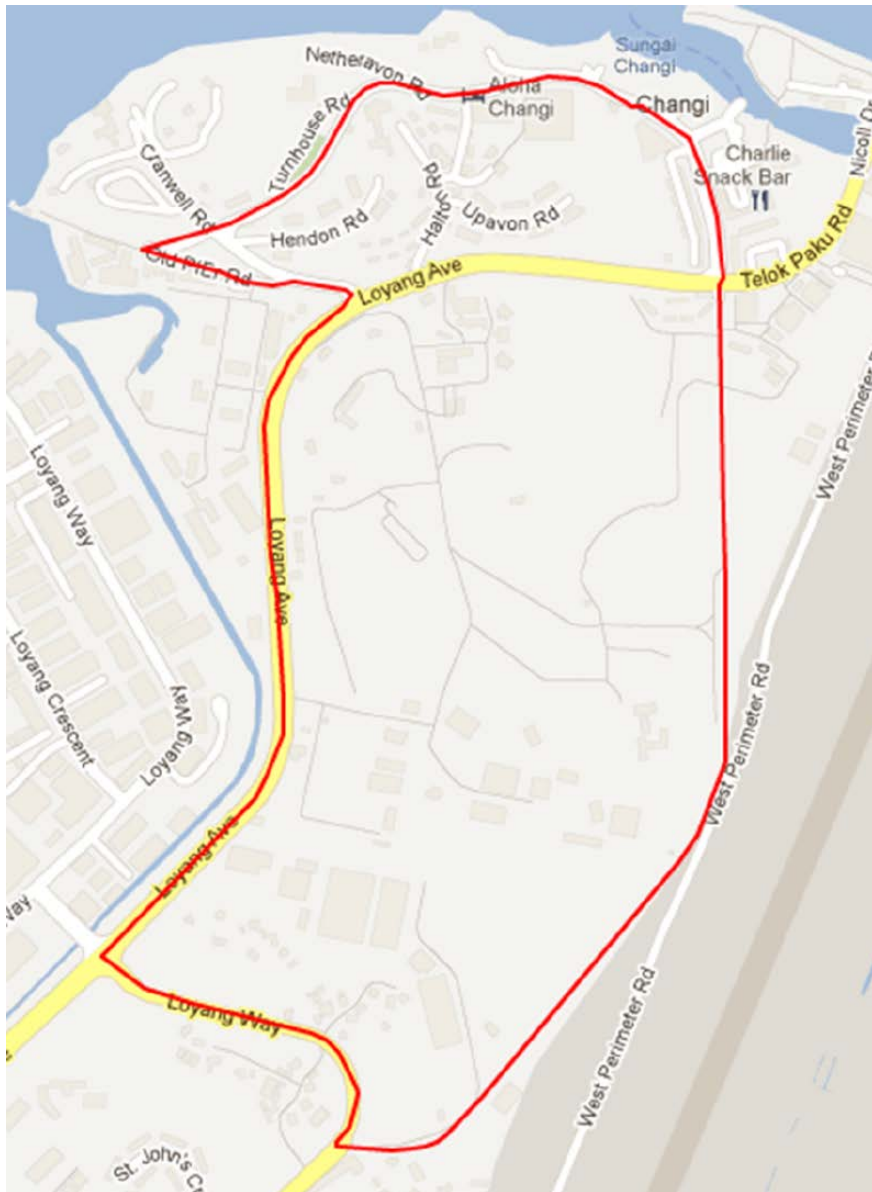

Changi TCA – Bounded by Netheravon Road, Cranwell Road, Loyang Avenue, Loyang Way, Upper Changi Road North and Changi Village Road.

Vacant Land

Mature trees growing on vacant land, similarly to trees within TCAs, are safeguarded from unnecessary felling. Prior written approval must be obtained from the Commissioner of Parks & Recreation for the removal of any tree with a girth of more than 1.0m, that measures at 1.0m from the ground and grows on a vacant land.

Vacant land is defined as:

- a. any land upon which no building or other structure exists; or
- b. any land where the Commissioner of Parks & Recreation has reasonable grounds to believe is not occupied by anyone; or
- c. any land upon which exists any building or other structure which is constructed or used contrary to any written law.

Roadside Greenery

NParks manages the greenery within the road reserve. This includes the trees, shrubs and turf within the roadside green verges and centre medium of the road. Roadside greenery is an important element of the street which serves to beautify and enhance the public spaces along the road. The spreading canopy of the trees also provides welcome shade to pedestrians and retains the location's unique streetscape identity. In order to prevent the unnecessary felling of trees, written approval must be obtained from the Commissioner of Parks & Recreation for the removal or cutting of any tree within road reserve.

Heritage Roads

The Heritage Roads scheme was implemented by the Government in 2005 to recognise and protect roads with lush roadside trees and multi-layered vegetation that create a “green wall” and/or “green tunnel” effect along certain roads. These roads create a sense of nostalgia and delight due to their distinctive and memorable landscape of continuous mature trees and greenery.

Heritage Roads are characterised by tall, matured green walls of natural vegetation. This gives the ambience of a lush tropical rainforest or a “green cathedral” effect. The Heritage Roads are gazetted and covered under Section 18 and 19 of the Parks & Trees Act 2005.

Written approval must be obtained from the Commissioner of Parks & Recreation for the cutting or removal of any tree or plant within a designated Heritage Road Green Buffer, and/or for any of the following:

- a. Altering, closing up or removal of any Heritage Road Green Buffers.
- b. Erecting or placing of any structure or object (whether temporary or permanent) in, above, across or under any Heritage Road Green Buffer.
- c. Erecting, constructing or laying within any Heritage Road Green Buffer any fence, retaining wall, foundation, manhole, pipe, cables, mains or any obstruction or structure (whether temporary or permanent).

List of Heritage Roads

No	Road Location	Estimated Distance (m)
1	Arcadia Road	918.0
2	Lim Chu Kang Road (between Ama Keng Road and Sungei Gedong Road)	1780.5
3	Mandai Road (between SLE and Mandai Avenue)	1084.0
4	Mount Pleasant Road	1353.0
5	South Buona Vista Road (between Stockport Road and Vigilante Drive)	1066.0

Overall Location Plan of Heritage Roads

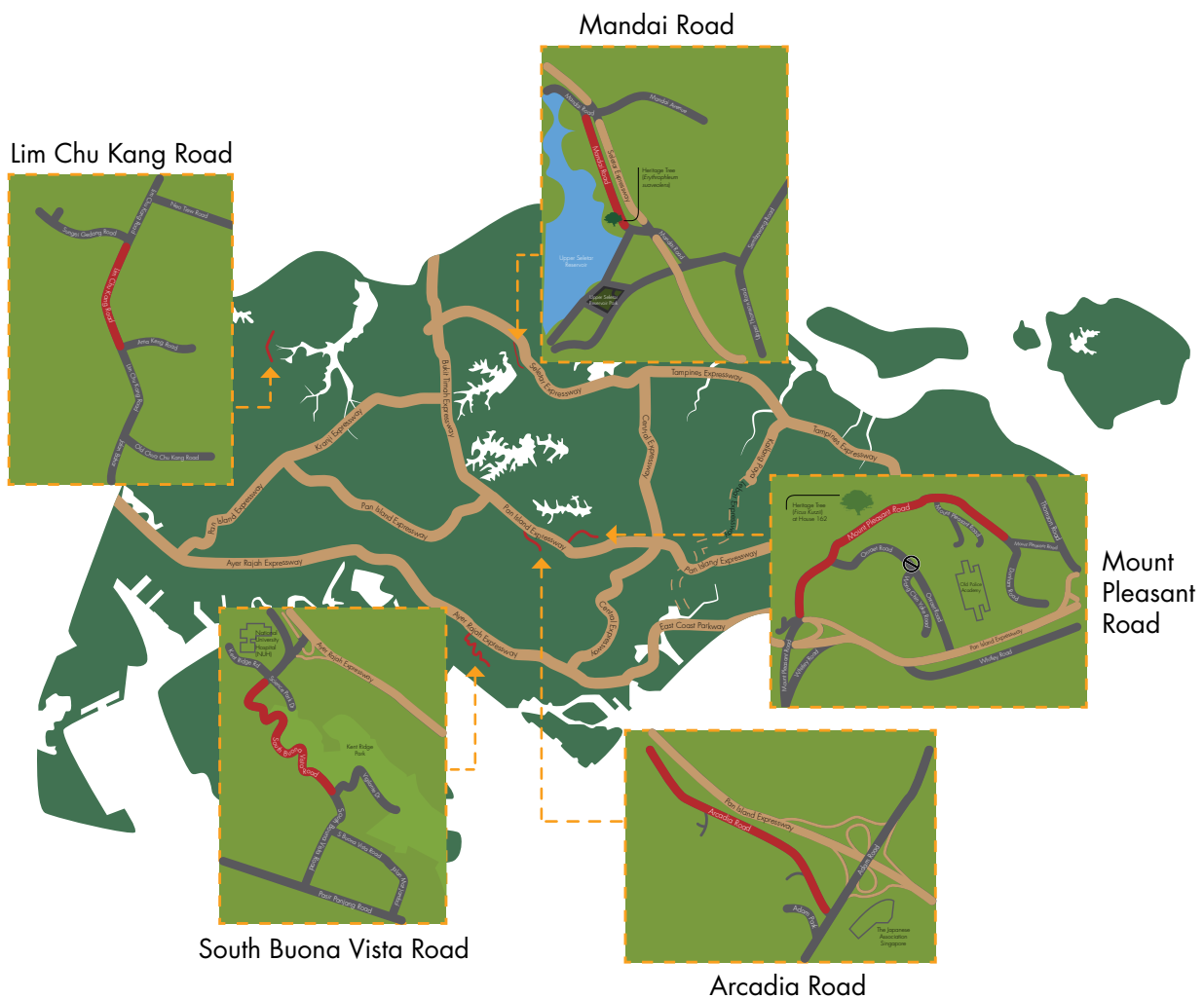

Arcadia Road



The shaded areas shown in the Heritage Road plans are designated as Heritage Road Green Buffers.

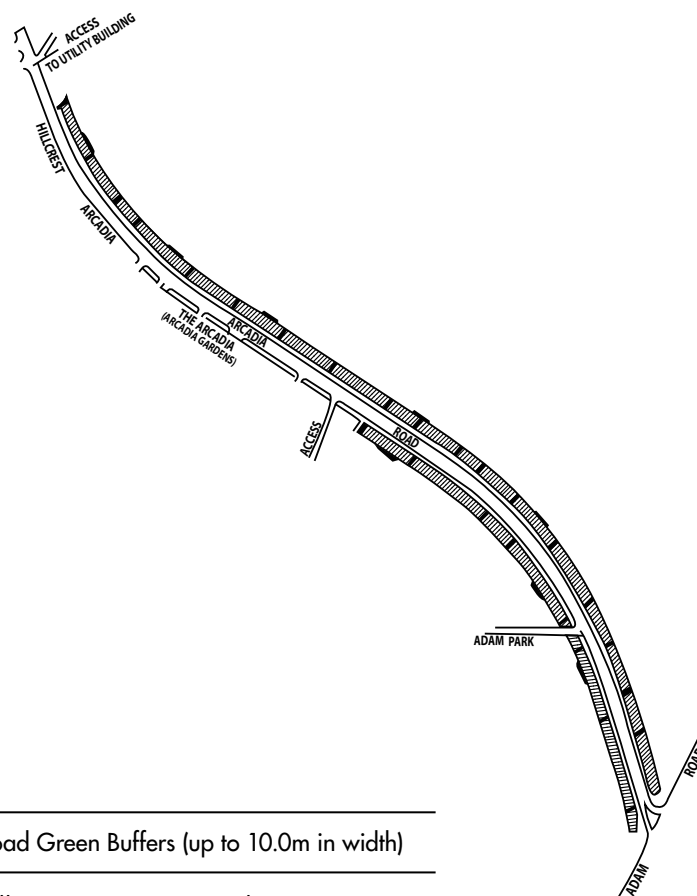



This image is for illustration purpose only.

Lim Chu Kang Road

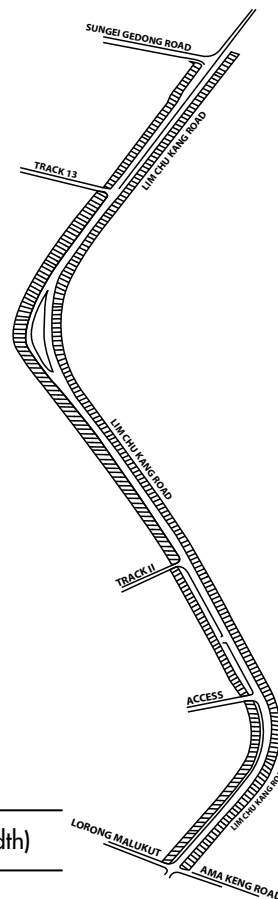

The shaded areas shown in the Heritage Road plans are designated as Heritage Road Green Buffers.



 Heritage Road Green Buffers (up to 10.0m in width)

This image is for illustration purpose only.

Mandai Road



The shaded areas shown in the Heritage Road plans are designated as Heritage Road Green Buffers.

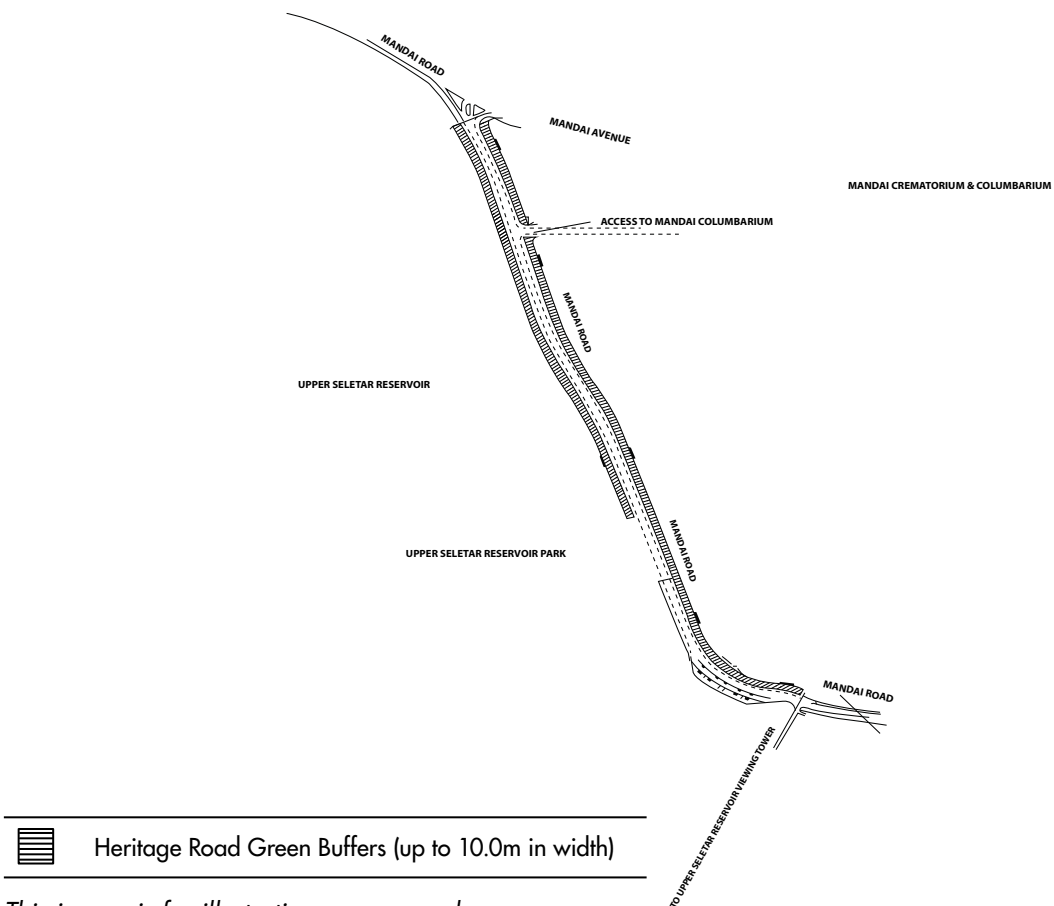



This image is for illustration purpose only.

Mount Pleasant Road

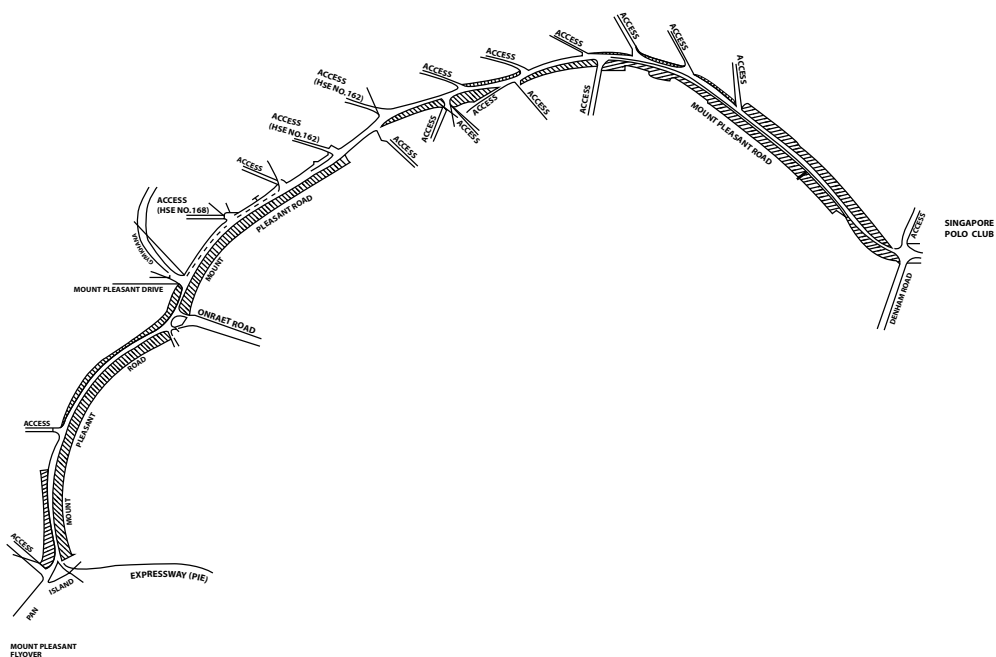

The shaded areas shown in the Heritage Road plans are designated as Heritage Road Green Buffers.



 Heritage Road Green Buffers (up to 10.0m in width)

This image is for illustration purpose only.

South Buona Vista Road



The shaded areas shown in the Heritage Road plans are designated as Heritage Road Green Buffers.

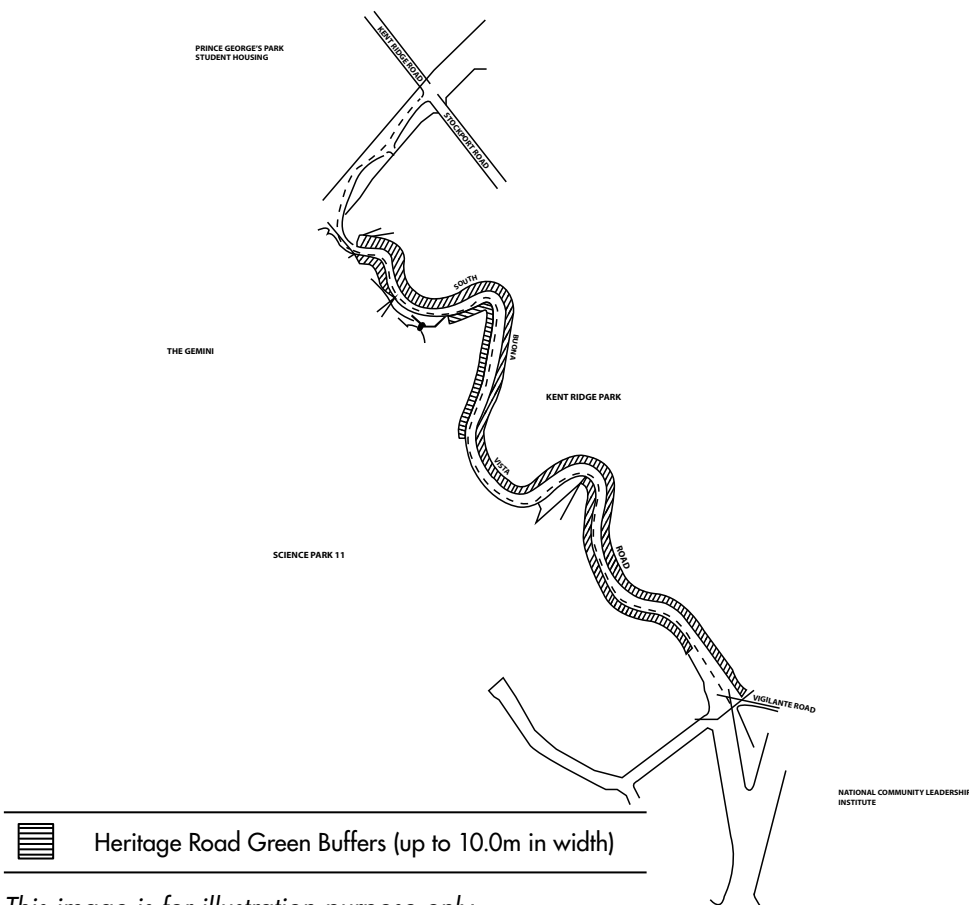

This image is for illustration purpose only.

Heritage Trees

Mature trees are the natural heritage of Singapore. They serve as important green landmarks of our City in Nature. With Singapore's rapid development, there is a danger of losing our national heritage to urbanisation. The Heritage Trees Scheme was announced on 17 August 2001 with the objectives to conserve and educate the community on the importance of protecting our mature trees.

Members of public can nominate suitable trees to be endorsed as Heritage Trees. For more information on the nomination process, qualifying criteria and listing of Heritage Trees, please visit NParks website.

Owners, developers and QPs are advised to consult NParks before removing any Heritage Trees.

Technical Requirements on Tree Conservation

Do you know that trees are susceptible to damage or injury? There is a potential threat to tree health and stability whenever there is an activity that happens around a tree. This includes construction works, storage of machines/equipment and vehicular movement.

Examples of Tree Damage due to Construction Activities



Lack of Tree Protection Zone

Change of soil level

Damage to trunk

Successful tree conservation within a development site occurs when the design, development and construction process has taken into consideration the condition of the site and surrounding areas. This is to minimise or prevent the impact to the trees. Hence, it requires the commitment of everyone involved in the process.

In order to safeguard trees from construction damage, Certified Arborists (CAs) are essential for evaluating tree risks, suggesting tree protection measures, reviewing tree conservation and providing alternative construction methods in avoidance of unnecessary tree damage and felling (refer to the Section on **Certified Arborist** in this chapter).

This section provides the technical guidelines to support the tree conservation efforts and minimise damage to trees.

Methods of Measuring Girth of a Tree

Generally, the girth of a tree is to be measured at 1.0m from ground level, except for multi-leader and low branching trees, as shown in the following images.

- a. For a simple trunk tree and buttress tree – measure the girth at 1.0m above the ground.

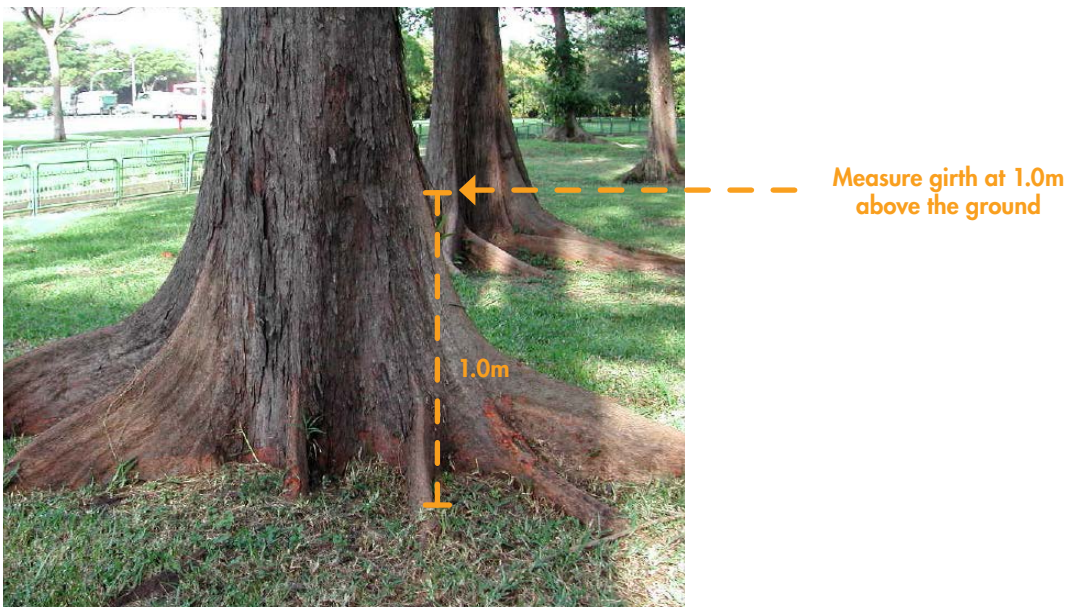

- b. For a multi-leader tree where the leaders sprout from the collar – measure the girth of each individual stem at 1.0m above the ground and treat each stem as a separate tree.

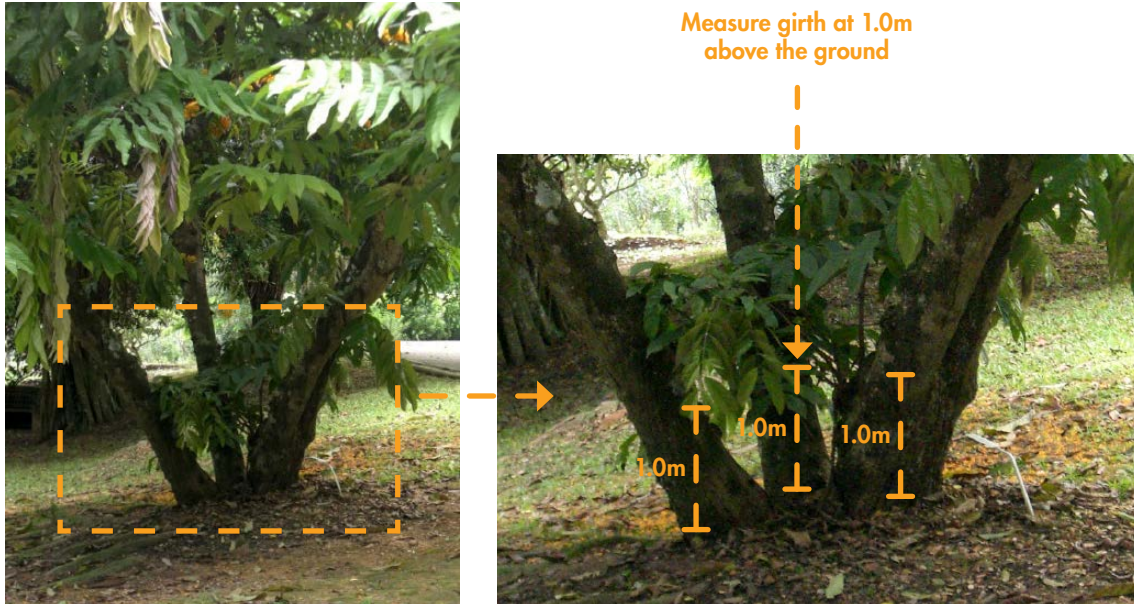

- c. For a low branching tree – measure the girth at the point of origin just below the lowest branching.

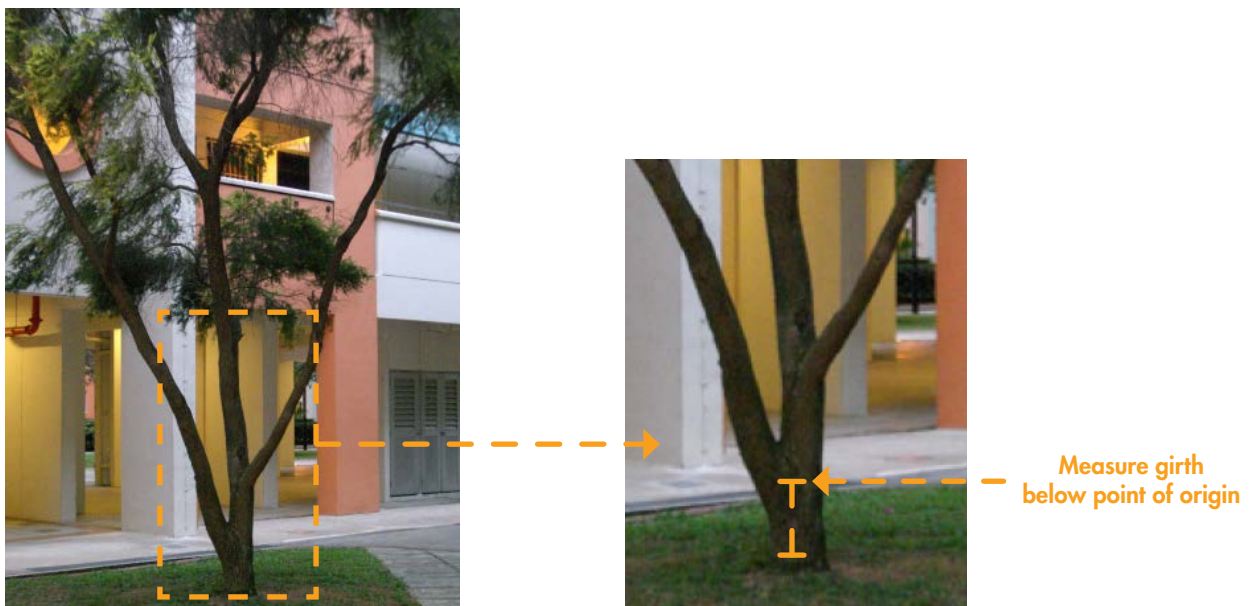

Tree Protection Zone

A Tree Protection Zone (TPZ) refers to an area identified to protect the entire tree, which includes its crown, trunk and roots system. The TPZ established should be able to protect the entire tree throughout the duration of construction.

The objective of the TPZ is to minimise the impact of construction activities on trees, including but not limited to mechanical injury to roots, trunks and branches due to contact with equipment, materials, debris or other activities. It also aims to minimise compaction of soil, which results in poor functioning of roots, and changes in soil levels that can cut off or suffocate roots.

The minimum protection zones from the centre of a tree are as shown in the following table.

Minimum Protection Zone from the Centre of a Tree

Girth (m)	Minimum Protection Zone
≤1.0m	2.0m
>1.0m but ≤1.5m	3.0m
>1.5m but ≤2.0m	4.0m
>2.0m	5.0m

The table above serves as a general guideline for tree conservation. It is advised to engage a CA to recommend the TPZ. Depending on both the crown and root spread, a larger tree protection zone may be required as determined on a case-by-case basis. This is especially so for trees with a girth of more than 2.0m.

Tree Protective Fencing/Hoarding

In order to successfully prevent tree damage, construction activities have to be diverted away from the trees. A good practice to prevent tree damage and ensure tree survival is to place a fence around the TPZ.

Bright orange polyethylene fencing or other effective tree protection fencing should be provided along the limits of the protection zone around the tree identified to be retained. This is to demark the TPZ within which activities are restricted before construction begins and kept intact until completion.

There must be no excavation, raising or lowering of soil level, compaction or any form of construction activities including temporary works within the hoarded area.

Dumping of debris, excavated materials and/or storage of construction materials and equipment is not allowed within the TPZ.

Protection hoarding is required, unless otherwise stated, and should be installed prior to site works. This is installed at point B (in the following illustration) around the edge of the protection zone.

Illustration of a Hoarding Demarking a Tree Protection Zone

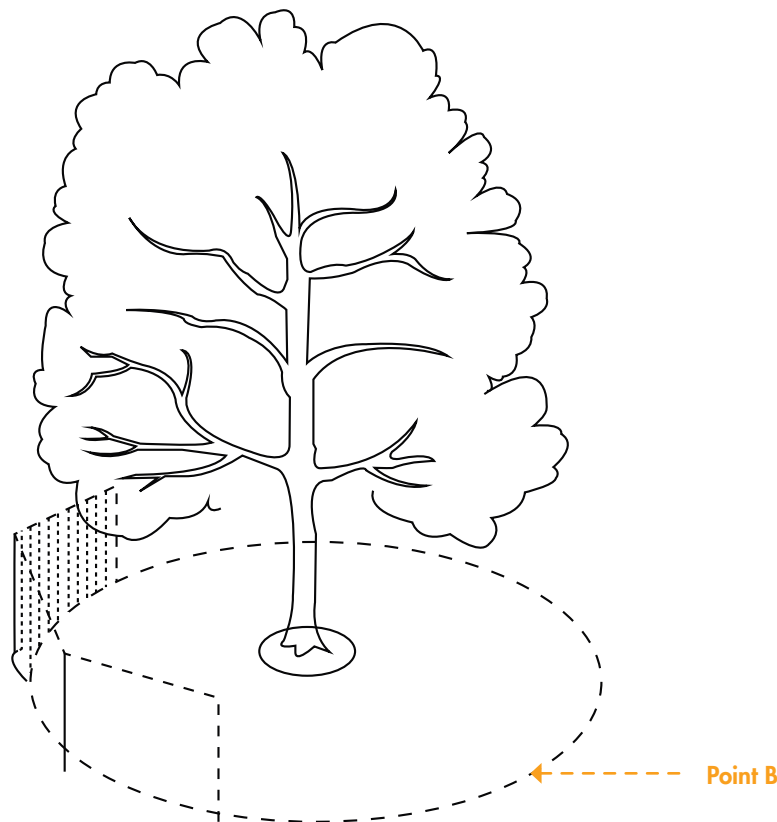

Example of a Good Tree Protection Hoarding



Example of a Poor Tree Protection Hoarding



Tree Protection Specification

Inside TPZ

- There must be no excavation, raising or lowering of soil level, compaction or any form of construction activities including temporary works within the hoarded area.
- Dumping of debris, excavated materials and/or storage of construction materials and equipment are not allowed within the TPZ.
- The demolition of drains, structures within the TPZ should be carried out manually and backfilled with Approved Soil Mixture (ASM) immediately.
- Trees are to be watered regularly if rainfall is inadequate.
- Trees are to be fertilised if soil tests or deficiency symptoms indicate they are nutrient stressed.

Outside TPZ

- If major roots are encountered during excavation, the applicant may like to seek advice from a CA, as cutting of major roots may affect the stability of the tree. Where possible, alternative proposals should be explored to avoid the need to cut the roots.
- In cases where the trees are managed by NParks (e.g. trees within the roadside verge), or are required by NParks to be conserved (e.g. trees with girth >1.0m within TCA or vacant land), approval from NParks must be obtained before the major root can be cut.
- If approval is granted by NParks to cut the roots, this must be done with a clean cut using a chainsaw.
- All building debris and chemical wastes should not be burned or buried within green verges on the site.

Certified Arborist

The CA plays an integral role in the development process. To ensure that all conserved trees are properly protected throughout each phase of construction, the CA should be engaged at the start of the planning stage to provide guidance on tree conservation matters.

Some of the roles of a CA include:

- Identify suitable trees for retention.
- Perform tree inspections and other relevant investigation works such as tree canopy mapping, tree root trenching, etc.
- Advise and carry out proper tree conservation measures.
- Conduct monitoring during the construction phase so as to ensure that trees are properly conserved (health and structural integrity of trees are not compromised).
- Prepare reports for documentation and approval.

Guidelines for Arborist Report

An arborist report is required when trees are identified for retention but may be affected by proposed works for development. The arborist report is useful as it documents the findings and recommendations of the CA. These include results of tree inspections, tree risk assessments, tree conservation methods and mitigation measures. In cases where trees are not suitable for retention, or technical/design solutions are not viable, the report should include the justification for tree removal.

The purpose of this section is to provide guidelines for the QP to submit an arborist report to NParks. All arborist reports shall be prepared by a CA. The subsequent section serves as a guide in drafting the arborist report for submission to NParks and should be presented in a comprehensive, clear and objective manner. The report is not limited to only the Visual Tree Assessment (VTA). It should also include tree impact assessment, tree conservation methods and mitigation measures in relation to the development works.

The report should comprise the following information:

Information on Certified Arborist	<ul style="list-style-type: none"> a. Registered name of CA b. International Society of Arboriculture (ISA) certificate number and expiry date of CA c. Company name and address (if applicable) of CA d. Contact number and email address of CA
--	--

Information on Subject Site and Development	<ul style="list-style-type: none"> a. Project title as registered in e-Corenet submission system and address of site (if applicable) b. Brief introduction of development proposal c. Date or period of assessment d. Date of report e. Site/layout plans showing location of all subject trees
--	--

Note:

On the site/layout plan, trees recommended for retention are to be shown in green and the recommended TPZ is to be clearly dimensioned. Trees recommended for removal are to be shown in yellow.

Tree Summary Table	<ul style="list-style-type: none"> a. Tree Identification Number (ID) of each tree which tallies with tree numberings shown on plans to be submitted by the QP b. Tree species c. Girth (in metres) d. Height of tree (in metres) e. Recommended TPZ f. CA recommendation on retention or removal of trees and the corresponding justifications
---------------------------	---

Visual Tree Assessment

Visual Tree Assessment (VTA) is a non-invasive method of evaluating the diagnostic symptoms of internal defects and measuring the probability of a tree failure. Further investigations using diagnostic decay instruments will sometimes be required to quantify these defects and determine if a tree actually poses a hazard. Remedial actions may have to be taken to reduce the risk of tree failure.

- a. All subject trees shall be assessed, evaluated and reported individually.
- b. All photographs shall be clearly captioned and annotated with tree species and ID number as shown in the following illustration.

Illustration of a Photograph of a Tree in Full View with Proper Annotation



T104 *Peltophorum pterocarpum* next to LP5 at Lawn E

- c. All subject trees shall be inspected as thoroughly as possible, such as through using the ISA Basic Tree Risk Assessment Form. If necessary, in-depth assessments using tree inspection tools and precision instruments are recommended to assess the full extent of defects. Examples of basic tree information required in the report are as follows:

Tree Characteristics

- a. Tree ID (corresponding to QP's plan)
- b. Tree species
- c. Common name
- d. Girth (in metres)
- e. Height of tree (in metres)
- f. Crown spread
- g. Tree form
- h. Live crown ratio
- i. Pruning history
- j. Special value

Tree Health

- a. Foliage color
- b. Foliage density
- c. Wound wood development
- d. Twig dieback
- e. Pests and disease

Tree Defects

- a. Lean with soil lifting/soil cracks
- b. Roots defect
- c. Trunk defect
- d. Branch defect

Site Condition

- a. Site character
- b. Recent disturbance
- c. Presence of soil lifting/soil cracks
- d. Obstructions
- e. Slope

Target

- a. Under the tree
- b. Occupancy
- c. Can target be removed

Note:

CA is to further assess the structural integrity of tree and evidence of structural weaknesses. Examples of structural weaknesses include weak included-bark unions and high percentage of deadwood. CA has to provide angle of lean and direction of lean with reference to the compass directions.

- d. All observations made shall be duly recorded and reported in a clear and objective manner. Examples on presentation of information that are required in reports are as follows:

Example 1

Tree with major decay and/or cavity using Resistograph and/or PiCUS

- Indicate the size, depth and location on the tree and direction of all cavities as shown in the following illustration.

Illustration of the Cavities Found at the Base of the Trunk with Annotations Showing the Directions and Depths of Cavity

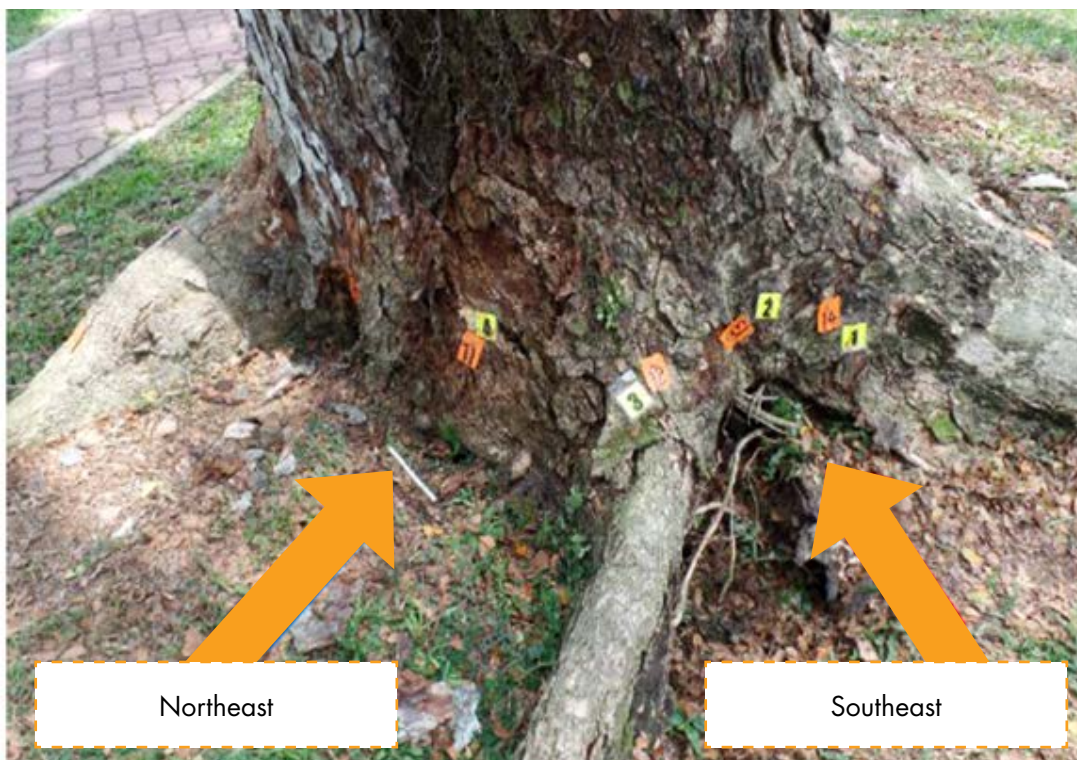

Open cavities and wounds found at Northeast and Southeast base of trunk. Probe inserted showed the depths of cavities to be more than 0.4m deep.

Note:

The direction is to be made in reference to the compass directions.

- Conduct in-depth assessment and further studies, if necessary, using tree decay detection equipment (e.g. Resistograph and/or PiCUS) as in the following illustration.

Illustration of the Use of Resistograph with Measurement Points Indicated in Yellow and PiCUS with Measurement Points Indicated in Blue

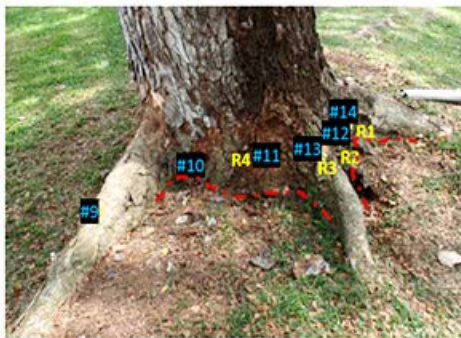
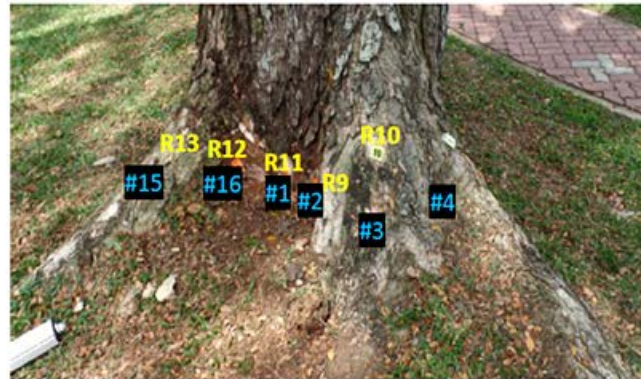
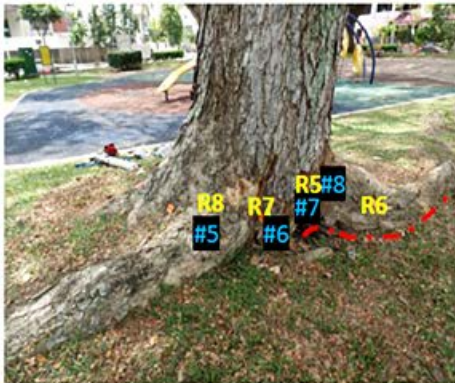

Interpretation and conclusion of findings are to be provided as shown in the following illustrations.

Illustration of Resistograph Drilling Carried Out at a Measurement Point with the Corresponding Interpretation and Conclusion



Resistograph drilling (R1) taken at trunk to root junction shows decay after 21cm. This indicates that decay has already infected partially at the underside of the tension root (BR1).

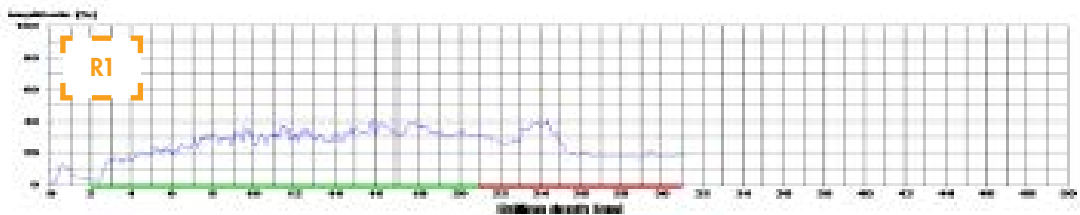
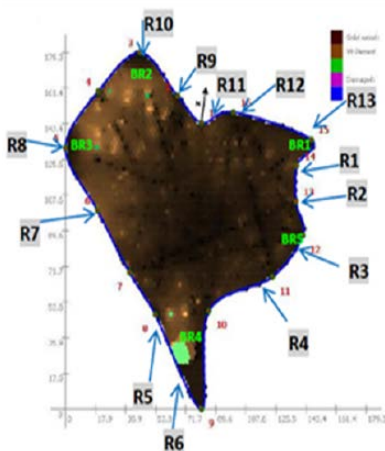

Illustration of a Tomograph Result with the Corresponding Interpretation and Conclusion



Tomogram results taken at lowest level at 150mm height indicates 99% sound and intact at the tested plane. Verification drills R1, R2, R4, R7, R9, R11 and R12 are carried out at a 45 degree angle at trunk base. R3, R5, R6, R8, R10 and R13 are carried out at buttresses.

- Confirm if decay is spreading.
- Assess if the decay can be mitigated and recommend remedial actions.

Example 2 Tree with lean

- Provide a brief description such as direction and degree of the lean as shown in the following illustration.

Illustration of a Leaning Tree with Angle of Lean and Direction Annotated on Photograph



- Confirm if lean is natural (e.g. phototropism).
- Verify if the tree has responded with a sweep.
- Assess if there is any lifting or mounding of soil at the base of the tree as shown in the following illustration.

Illustration of a Leaning Tree with Signs of Mounting of Soil at Base of Tree



- Assess if there are cracks in the soil or distinct gaps between the roots and soil as shown in the following illustration.

Illustration of a Leaning Tree with Cracks in the Soil



- Provide detailed assessment of the roots and root systems (e.g. presence or absence of tension or compression roots).
- Assess whether there are targets and the potential of failure.

Note:

The direction of lean is to be made in reference to the compass directions.
The angle of lean is to be measured from the vertical.

Tree Impact Assessment

The Tree Impact Assessment is an evaluation of the adverse impacts of construction activities on tree health and stability. Measures and treatments may have to be taken to mitigate the risk of tree failure.

- a. Detailed impact assessment of proposed works on tree shall be done and reported individually with comprehensive illustrations, explanations and recommendations.
- b. Assessment on impacts of excavations and paving works on tree health and stability will have to be made. Root exploratory trenches/holes are required if proposed works are in close proximity or encroach into the recommended TPZ of subject tree. All excavation works are to be done manually and supervised by the CA. Strictly no roots are to be damaged/cut. The detailed information should comprise:
 - Site and cross-sectional plan showing location of trees, proposed works and trenches with clear dimensions as shown in the following illustrations.

Illustration of a Site and Cross-Sectional Plan Showing Subject Tree in Relation to Nearby Proposed Works

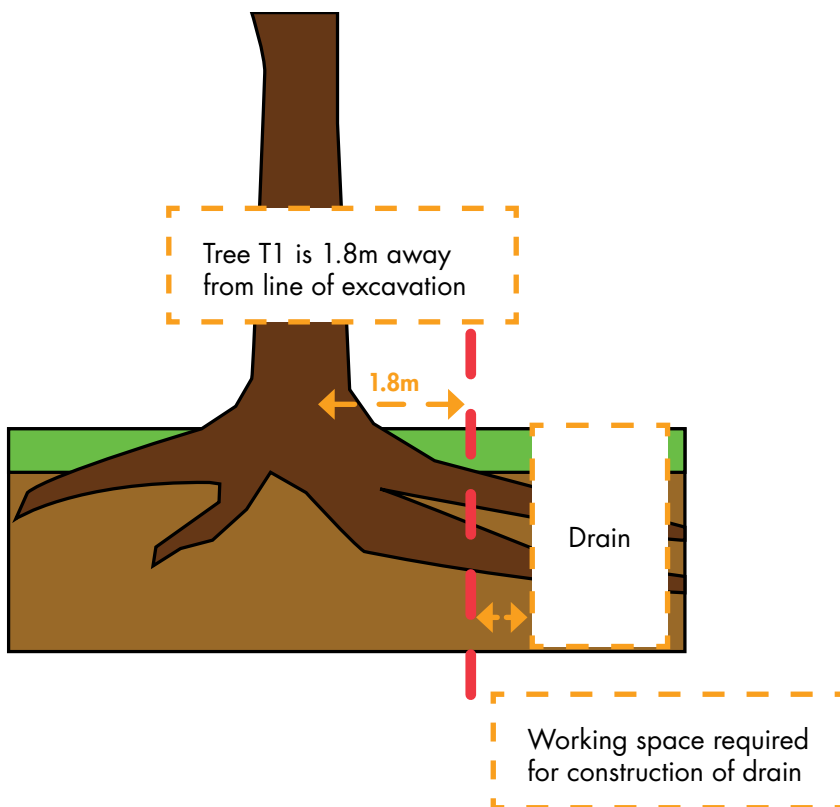
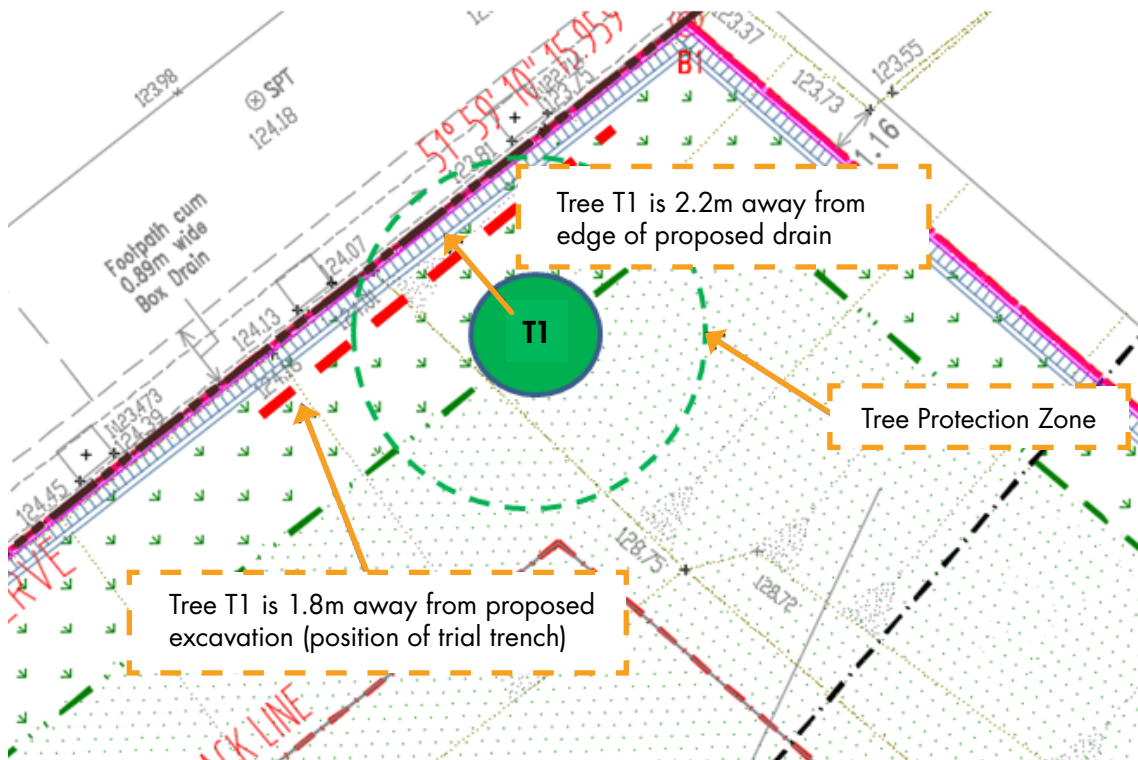

- Photographs showing location of root exploratory trenches and holes dug up at the actual position of excavation as shown in the following illustration.

Illustration of a Tree in Relation to Proposed Works (with Clear Dimensions and Annotations)

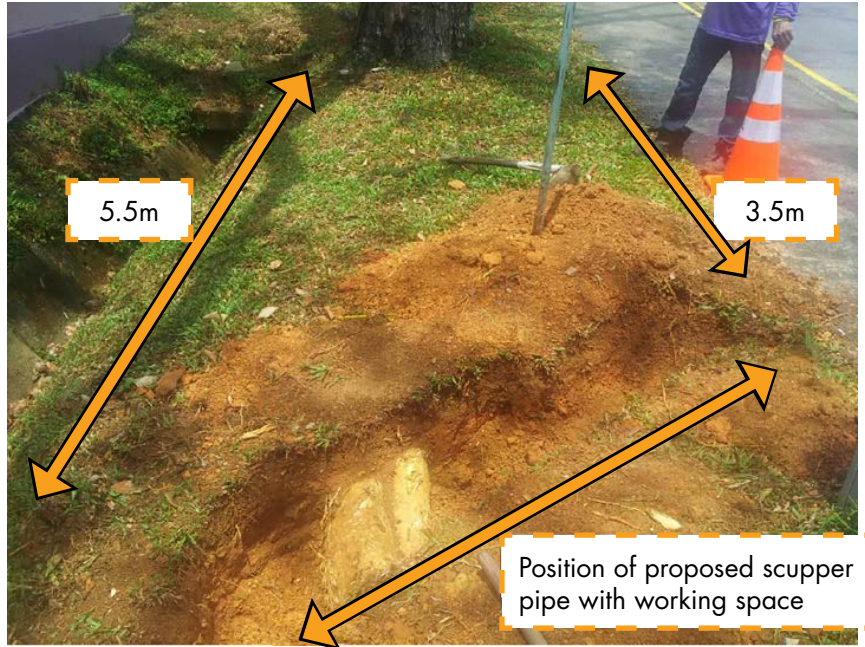

- Photographs of root exploratory trenches and roots found in trenches (with girth sizes and depth) as shown in the following illustration.

Illustration of Roots Found in Root Exploratory Trench (Roots are Labelled with the Corresponding Girth Sizes and Depth)

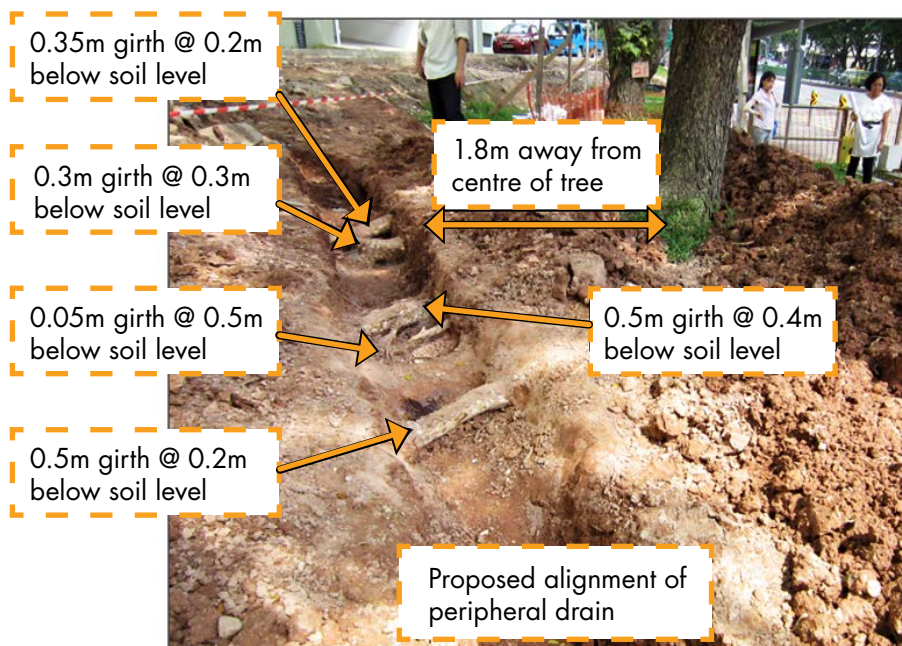

- Recommendation on percentage of root cuts and its impact on tree health and stability, if roots cannot be avoided.
 - Proposed construction method statement and tree conservation measures for proper tree conservation.
- c. Assessment on impacts of proposed pruning works on tree health and aesthetic as a result of necessary headroom height clearance. The detailed information should comprise:
- Site plan showing location of the trees and proposed works.
 - Photographs of required headroom clearances in relation to trees and branches as shown in the following illustration.

Illustration of Required Headroom Clearance in Relation to Tree and Branches due to Proposed Works

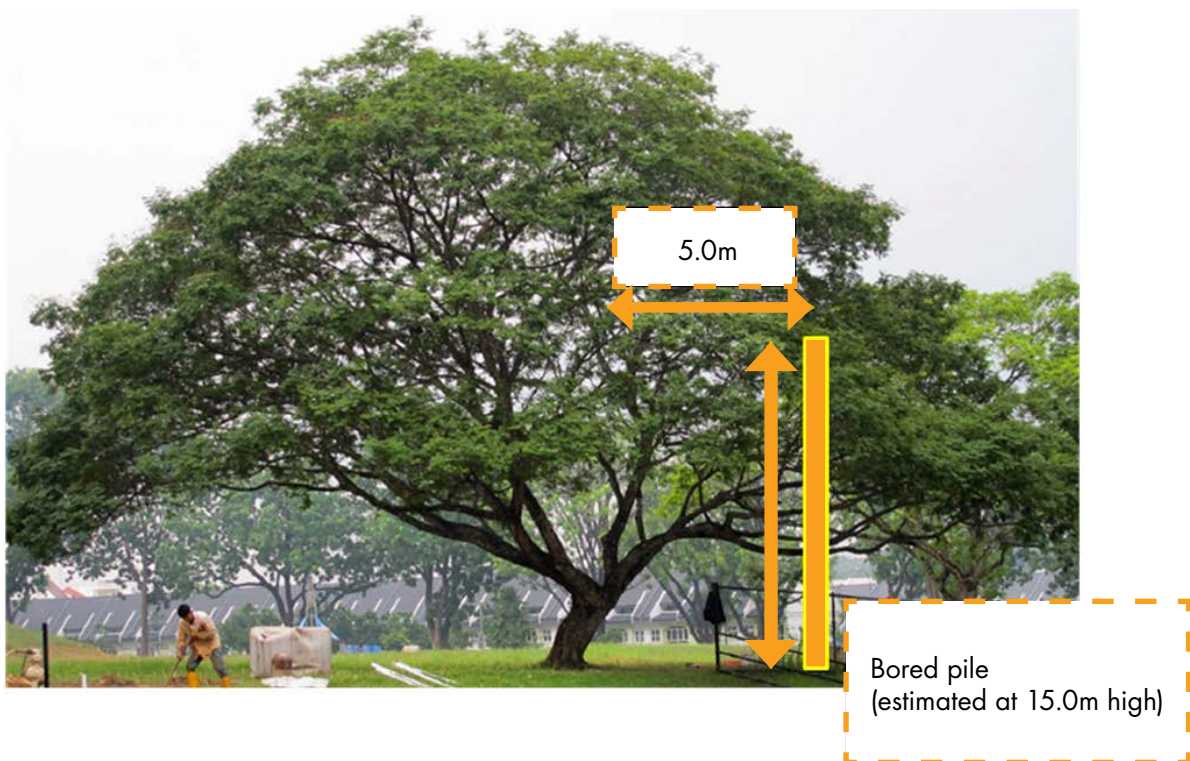

- Recommendation on the numbers and percentage of branch cuts and impact on tree aesthetic and health, if branches cannot be avoided as shown in the following illustration.

Illustration of Percentage of Crown Affected in Relation to Proposed Works

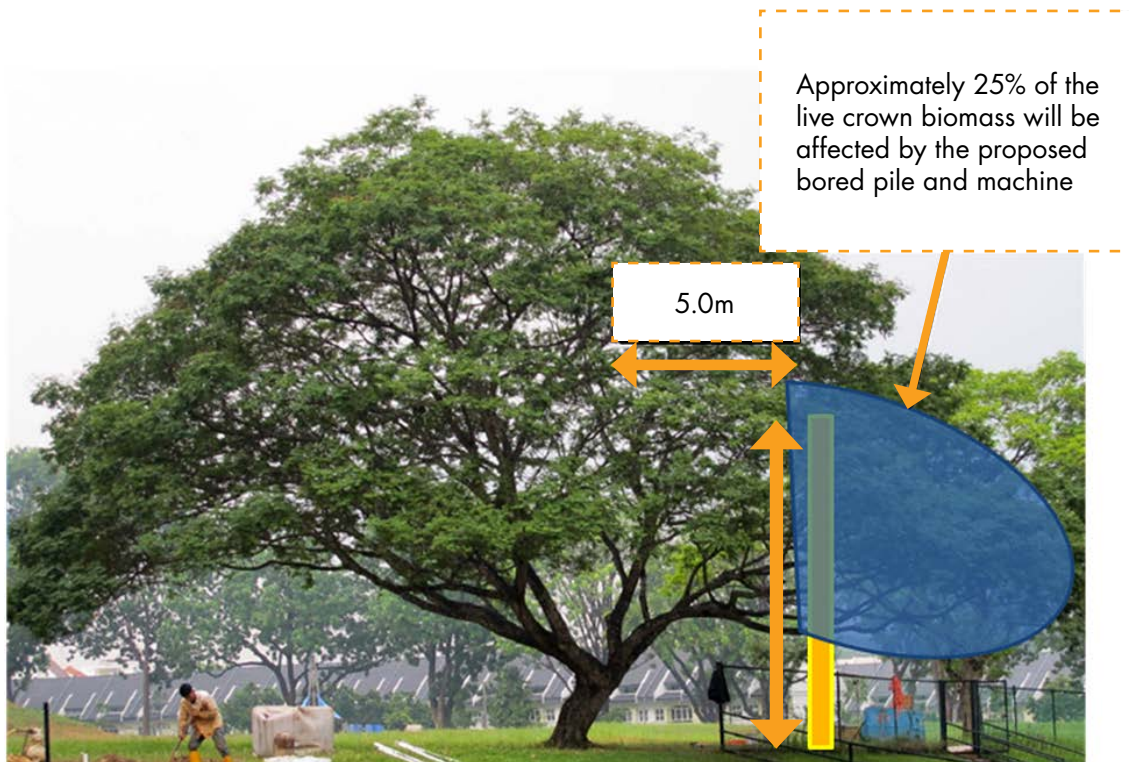

- Necessary measures and follow-up actions are to be taken for proper conservation of tree.
- d. Assessment on impacts of proposed changes in soil levels on tree health and stability. The detailed information should comprise:
- Details on the change in soil level for each individual tree as shown in the following illustration.

Illustration of Change in Soil Level due to Backfilling Works

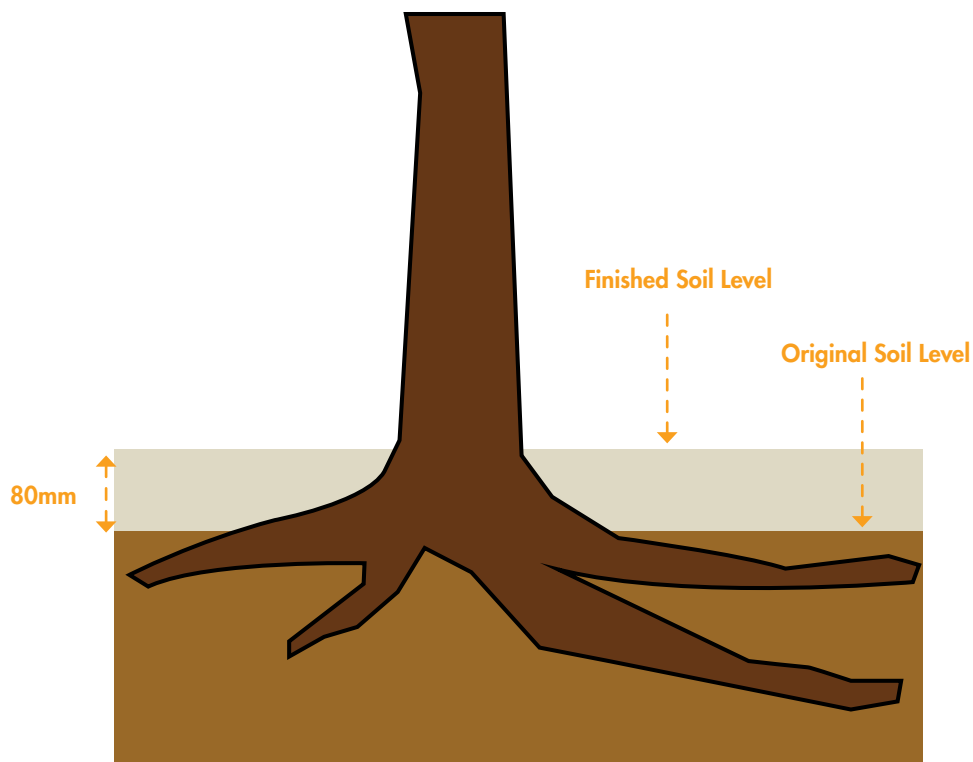

- Impact of proposed soil level change on tree health and stability.
 - Necessary measures and follow-up actions are to be taken for proper conservation of tree.
- e. Summary of findings
- CA to provide a discussion of the overall findings from the Visual Tree Assessment and Tree Impact Assessment for each tree.
- f. Decision
- CA to recommend retention, removal or transplantation of affected tree with proper reasoning.
- g. Follow-up action
- CA to propose tree preservation methods and mitigation measures for each tree.

3 GREENERY PROVISION WITHIN PREMISES

Greenery is essential in the urban built environment as it provides multiple benefits. It enhances the quality of life and improves the urban environment and its eco-systems. Greenery also helps to regulate temperature, improves air quality and increases biodiversity, which in turn improves our physiology and mental health.

With population growth resulting in increasing demand for space, land set aside for greenery can also become scarce. As such, a set of requirements on greenery provision within premises serves to ensure constant pervasive greenery so as to create a pleasant living and working environment for all.

Requirements on Greenery Provision within Premises

Green Buffer

Green buffer is the planting area within and along the boundary of a premises adjoining a public road. When planted up lushly with trees and shrubs, it serves as a buffer between the development and the road, and contributes to a more pleasant internal environment. The green buffer is also important in augmenting the roadside greenery, which is a key element of our City in Nature.

Green buffer is required along the sides of the development boundaries that front a public road. The width of the green buffer, which is a segment within the road buffer, shall be provided in accordance with the road category. The classification of the road category is available from Land Transport Authority (LTA) through the purchase of the Road Line Plan (RLP). Please refer to the subsequent table on **Green Buffer Requirements for Development Boundaries Fronting Roads**.

Green buffers should generally be flat to the ratio of 1:40. If site situation does not permit, the proposed slope should not be steeper than the ratio of 1:2.5.

Note:

- The provision of the green buffer is exempted for the side(s) of the landed housing development adjoining Category 5 road.
- The landed housing development above refers to a good class bungalow, a detached house, a bungalow, a semi-detached house or a terrace house.

Green Buffer Requirements for Development Boundaries Fronting Roads

Classification of Road Based on Road Interpretation Plan	Proposed Use/ Development	Green Buffer Width
Category 1	All developments	5.0m
Category 2	Residential/educational	5.0m
	Commercial/industrial/institutional/place of worship	3.0m
Category 3	All developments	3.0m
Category 4-5 & slip roads	All developments	3.0m

Note:

- For Non-Category road, green buffer provision will be based on the road category that best matches the road reserve width.
- In cases where setback requirements are altered, NParks may revise the width of the green buffer accordingly on a case-by-case basis.

Peripheral Planting Verges

Peripheral planting verges provide a quality green and pleasant space between neighbouring developments, to be enjoyed by both developments as well as contributing to the overall greenery in Singapore.

A minimum of 2.0m wide peripheral planting verge is to be provided along all sides of development boundaries except where it fronts a public road. In such situations, a green buffer that corresponds to the road category shall be provided.

The 2.0m wide tree planting verge should generally be flat to the ratio of 1:40. If site situations do not permit, the proposed slope should not be steeper than the ratio of 1:2.5.

Note:

The provision of the peripheral planting verge is exempted for the following developments

- Landed housing developments (i.e. a good class bungalow, a detached house, a bungalow, a semi-detached house or a terrace house).
- Industrial or warehouse developments on land zoned as "Business 1", "Business 1-White", "Business 2" and "Business 2-White" under URA's Master Plan where the side(s) of the premise adjoins another industrial or warehouse development.

Green Buffers and Peripheral Planting Verges Requirements within a Premise

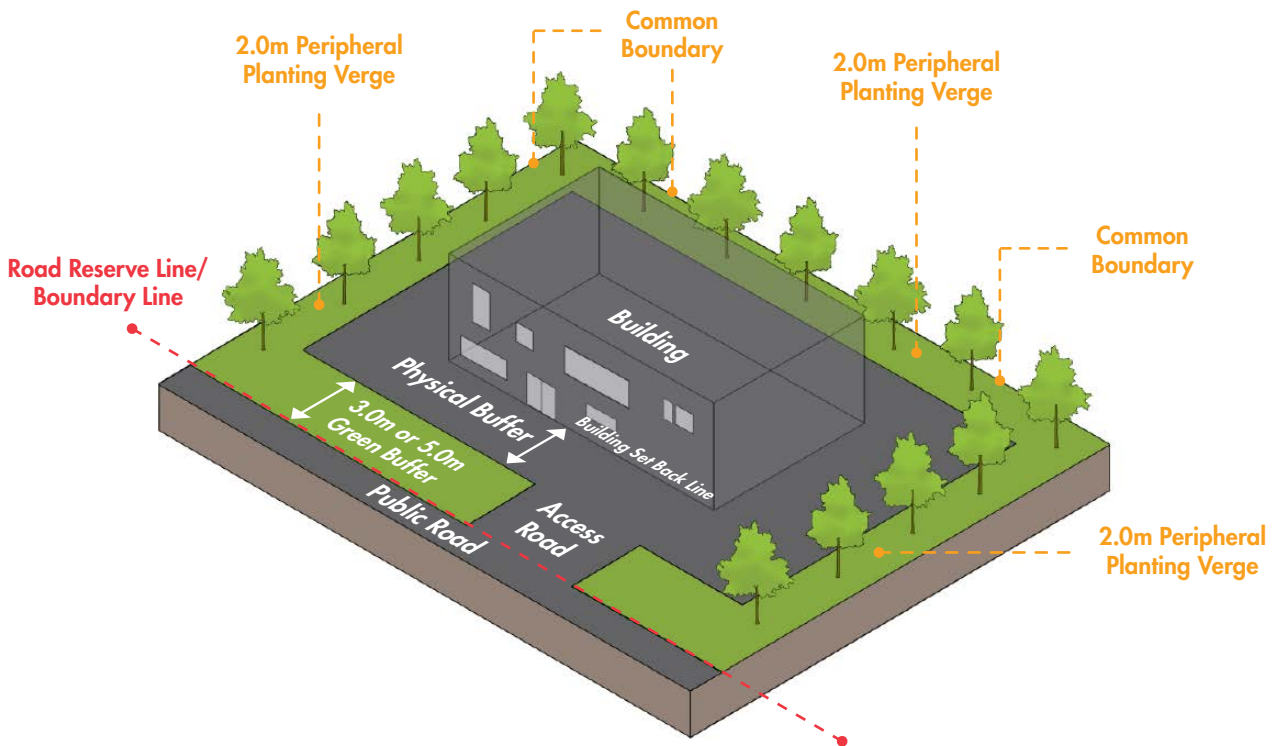

Gradient of Green Buffers and Peripheral Planting Verges

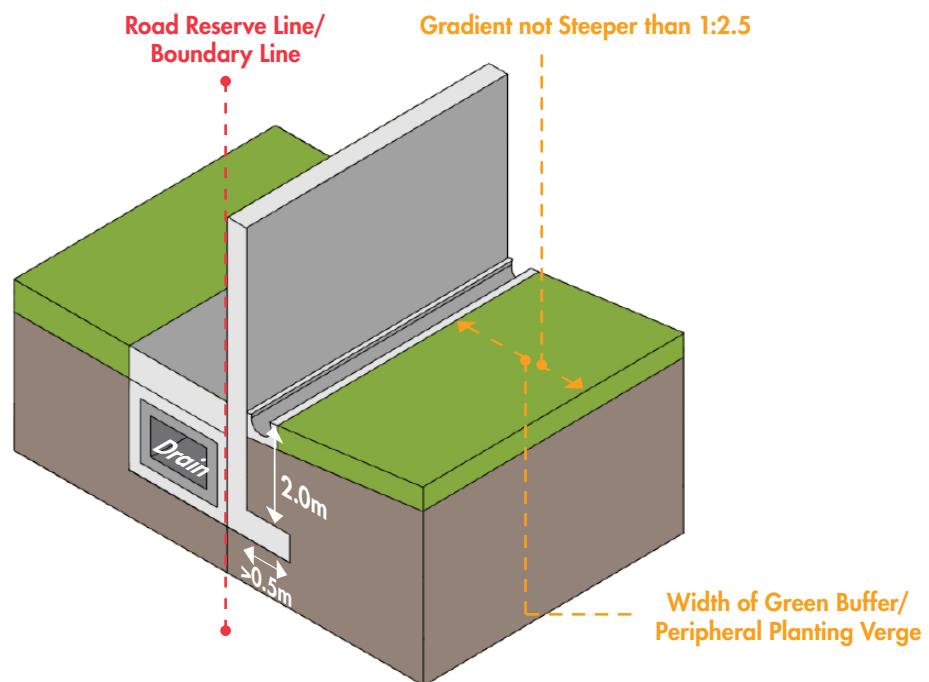

Note:

Footing of the wall should be recessed at least 2.0m below the proposed ground level if it encroaches more than 0.5m into a peripheral planting verge.

Specific Developments Exempted from Provision of Green Buffers and/or Peripheral Planting Verges

Some developments are exempted from the provision of green buffers and/or peripheral planting verges along specific sides of the development.

Specific Developments Exempted from Provision of Green Buffers and/or Peripheral Planting Verges

No	Development	Type of Planting Area Exempted
1	Landed housing developments	Peripheral planting verges Green buffers for the side of the premises adjoining a Category 5 road
2	Industrial and warehouse developments on land zoned as "Business 1", "Business 1-White", "Business 2" and "Business 2-White" under URA Master Plan	Peripheral planting verges for the sides of premises adjoining another industrial or warehouse development
3	All developments	Tree planting verges for open air parking area at street level used as a loading/unloading bay
4	Specified premises as listed in Appendix B (see Chapter 10 on Appendices)	Green buffers and peripheral planting verges

Note:

- The above mentioned developments are exempted from provision of green buffer and/or peripheral planting verges only if the landuse type and development type remain unchanged.
- Please note that you may still be required to make a DC application to NParks even if greenery provision within the development has been exempted. Refer to Chapter 8 on **Submission Procedures** for NParks' DC application requirement.

Alternative Green Buffer Configuration

For developments with considerations such as technical constraints or with special design intents, alternative configurations of the green buffer provision can be considered on a case-by-case basis.

Such configuration must fulfil the following conditions:

- A minimum clear width of 2.0m planting verge must still be provided along the same side(s) of the development boundary, where applicable.
- The final area of green buffer allowed to be configured within the same side of the development boundary shall not be less than the original area of green buffer required.

You may refer to the following illustrations as examples of alternative green buffer configuration.

Figure 1 Example of Alternative Green Buffer Configurations for Developments with Other Site Considerations (Diagrammatic Plan View)

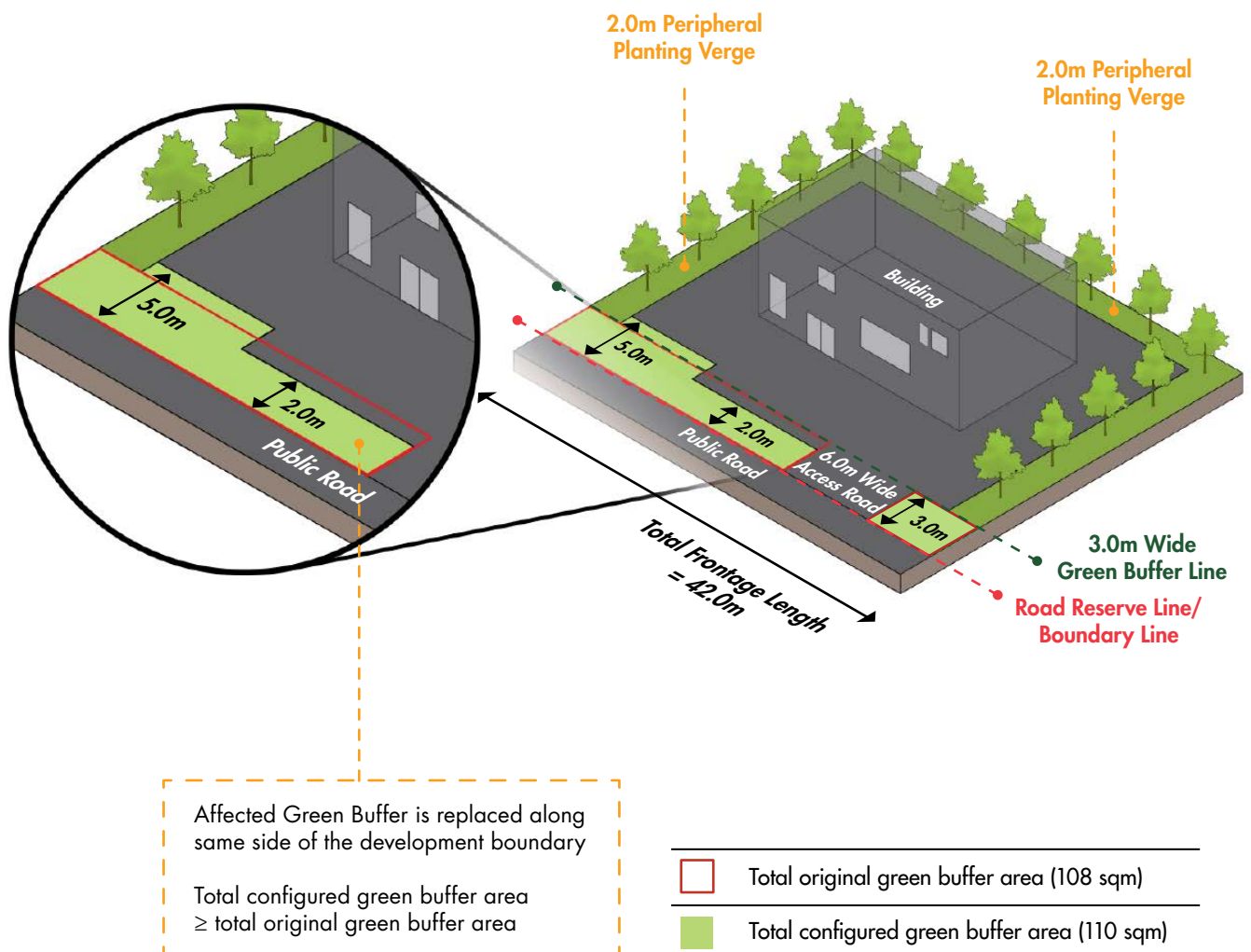
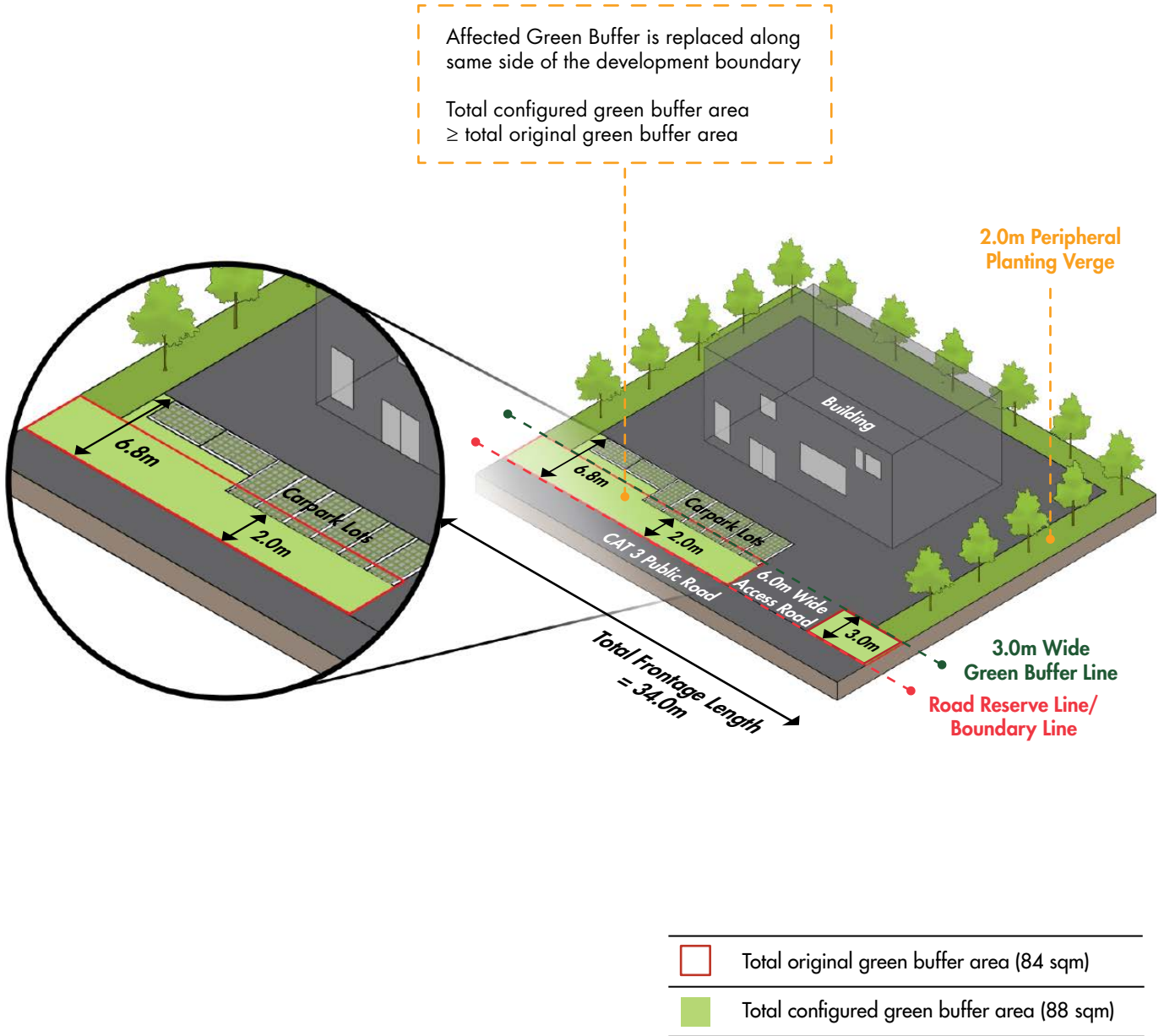

Figure 2 Example of Alternative Green Buffer Configurations for Developments with Other Site Considerations (Diagrammatic Plan View)



Plantings within Green Buffers and Peripheral Planting Verges

- a. There should be sufficient amount of shade tree planting and landscaping to enhance the built environment and provide screening while reducing glare and heat. The planting pattern can be singular in regular planting distance or cluster planting.
- b. Plantings within green buffers and peripheral planting verges are recommended to have a mosaic of trees, shrubs and groundcovers to create a lush and multi-tiered landscape.
- c. There shall be adequate space for trees to grow to their full spread and height; hence, no structures should be close to the tree.
- d. The tree planting strips should be true ground or with soil area large enough to accommodate the particular rooting habits. They must be free from encumbrances.
- e. An established and lush landscape upon project completion should be achieved through planting of larger trees and denser foliage at the installation period.
- f. Allowable structures proposed within the tree planting strips should be screened by landscape or contribute to the landscape efforts. Height of structures should be suitable for the intended use and not hinder the growth of trees.
- g. Good practices on plantings within green buffers and peripheral planting verges are shown in the following images.

Good Practices of Plantings within Green Buffers and Peripheral Planting Verges



Developments Bordering Drainage Reserves

For developments that border drainage reserves (DRs), peripheral planting verges or green buffers shall be provided after the drainage reserve line.

Where a DR is not required to be vested to the State, peripheral planting verges or green buffers may be provided above the drainage reserve (after the road reserve line), subjected to a provision of minimum 2.0m soil depth. The following scenarios are illustrated as reference.

Scenario 1 DR to be vested back to the State

Where DR is required to be vested back to the State, peripheral planting verges or green buffers shall be provided after the drainage reserve line.

DR to be Vested Back to the State

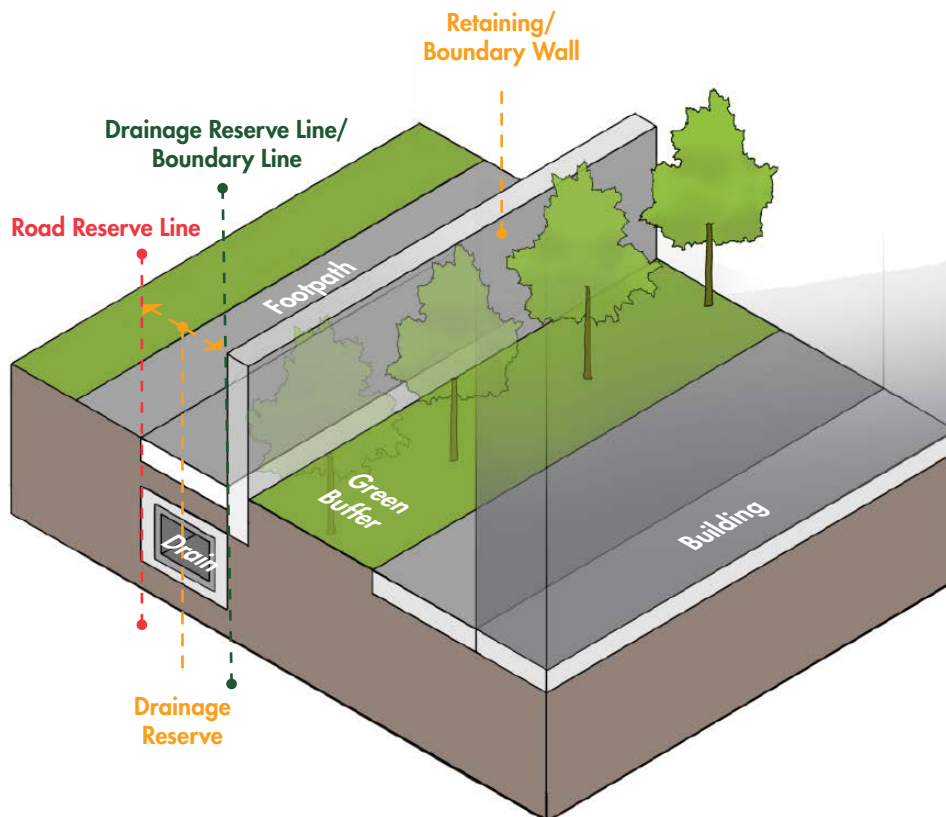

Scenario 2**DR not required to be vested back to the State**

Where DR is not required to be vested back to the State, peripheral planting verges or green buffers may be provided above the DR (i.e. after road reserve line), subject to a provision of minimum 2.0m soil depth for tree planting.

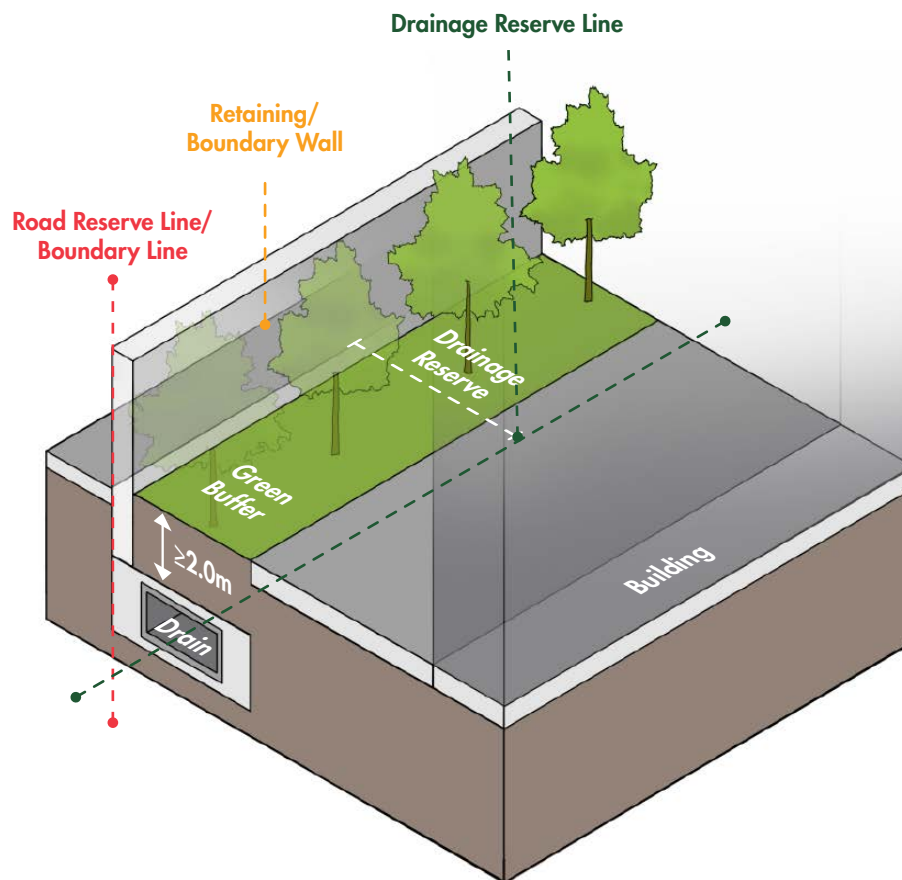
DR not Required to be Vested Back to the State

Scenario 3**DR not required to be vested to the State and has soil depth less than 2.0m**

Where DR is not required to be vested back to the State and the provision of minimum 2.0m soil depth cannot be achieved, peripheral planting verges or green buffers are to be provided after the drainage reserve line.

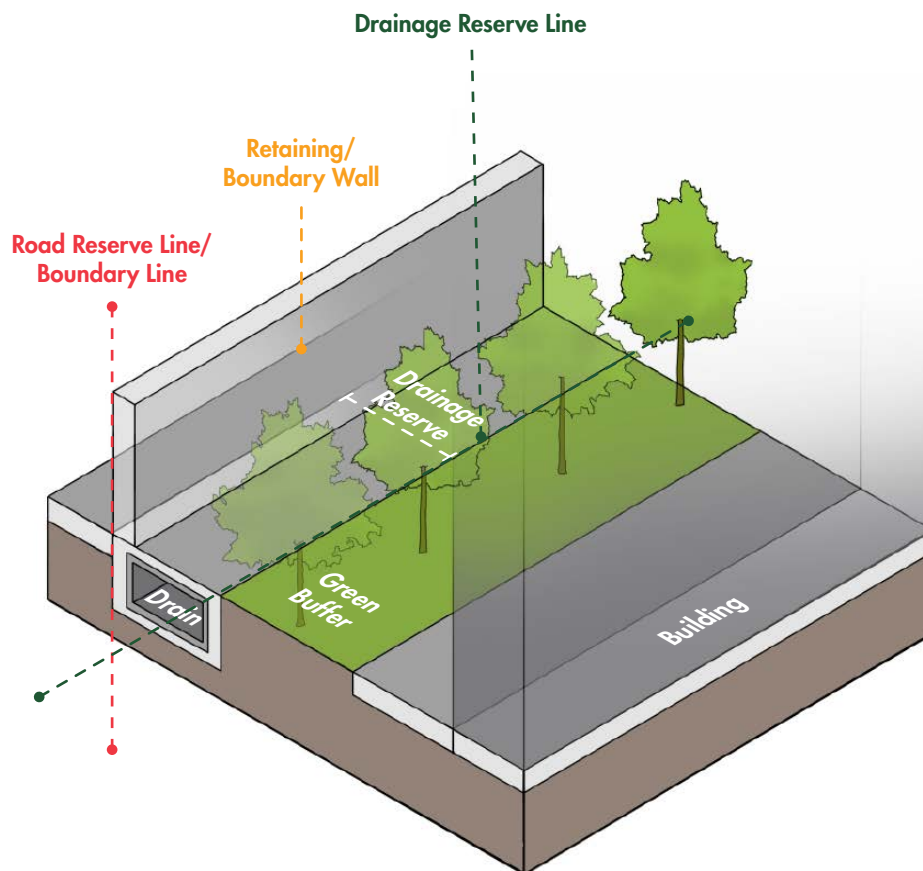
DR not Required to be Vested Back to the State and Soil Depth <2.0m

DR Located within Development Side and abutting Peripheral Planting Verge

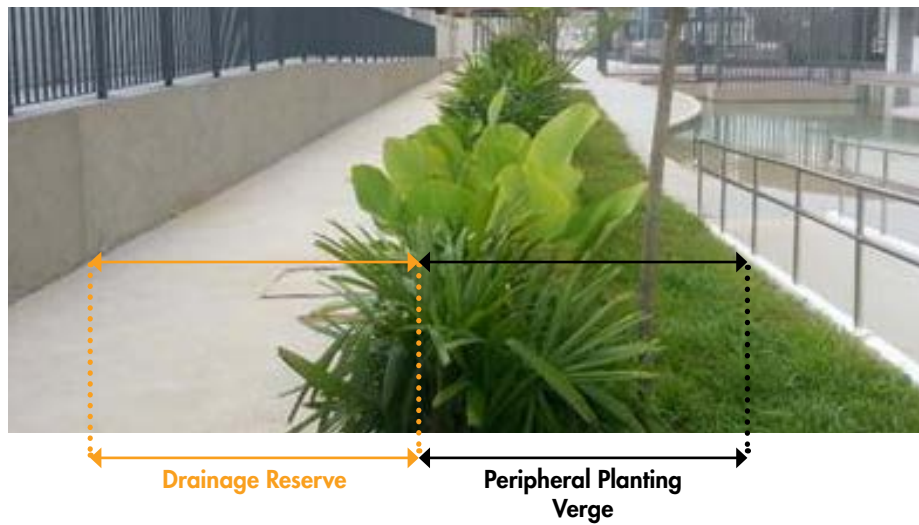

Retaining/Boundary Wall along Green Buffers and Peripheral Planting Verges

The width of green buffers and 2.0m wide peripheral planting verges should exclude the boundary/retaining wall. Footing of the wall should be recessed at least 2.0m below the proposed ground level if it encroaches more than 0.5m into a planting verge.

Boundary Wall Abutting Green Buffers/Peripheral Planting Verges

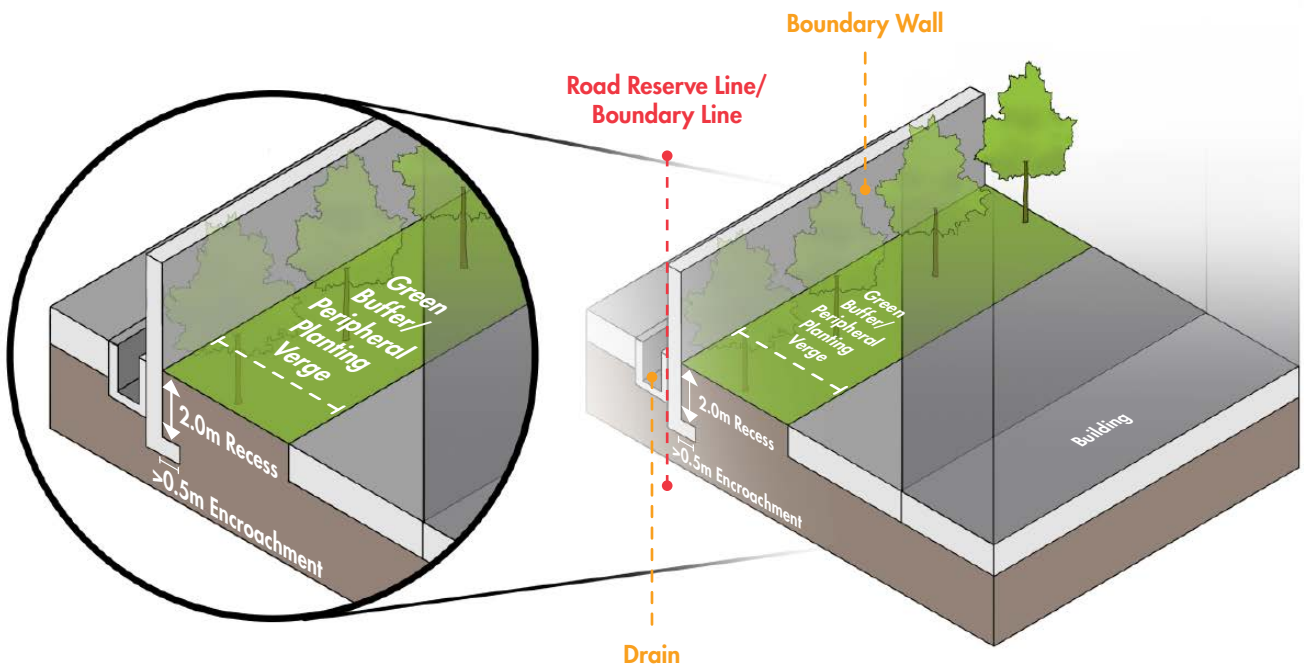

Retaining Wall Abutting Green Buffers/Peripheral Planting Verges

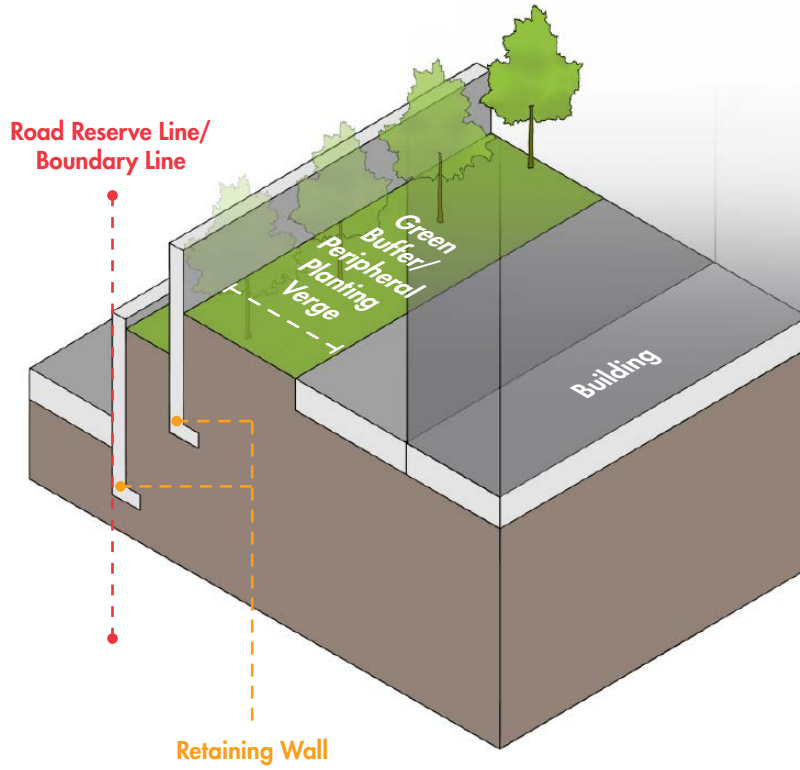

Retaining/Boundary Wall (>0.5m Encroachment) abutting Green Buffers/Peripheral Planting Verges

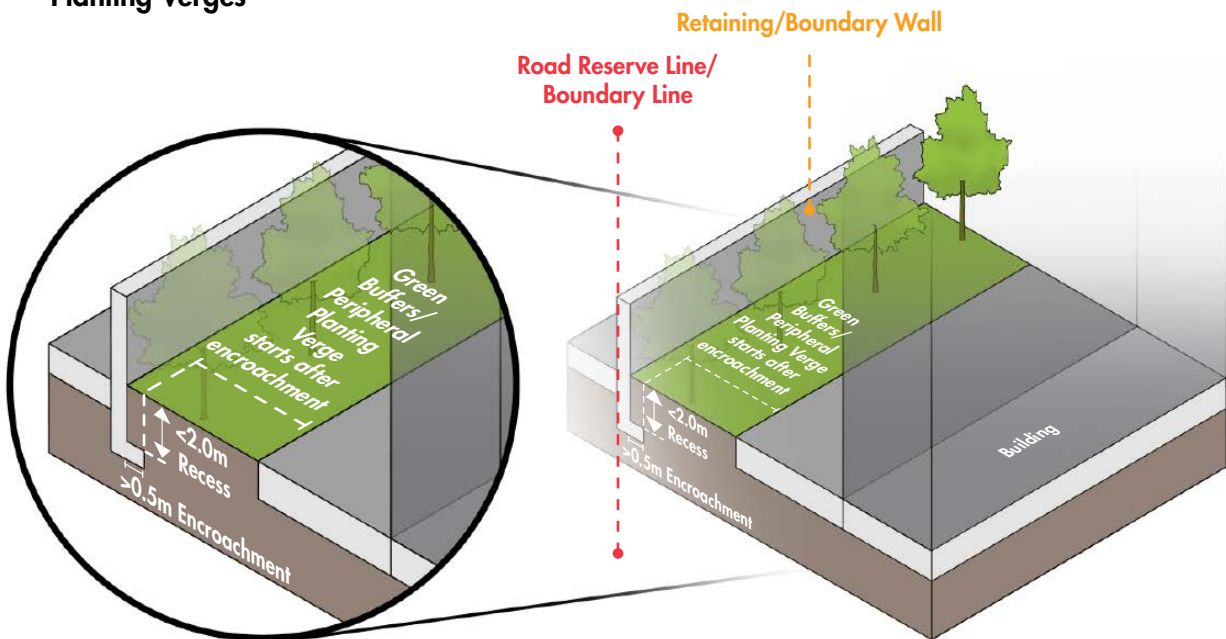

Submerged Basement Structure within Green Buffers and Peripheral Planting Verges

Submerged basement structures which encroach into green buffers and/or peripheral planting verges should be at least 2.0m below the ground level.

Headroom clearance for basement must be taken into consideration in the early planning and design stage of the development.

Submerged Basement Structure within Green Buffers/Peripheral Planting Verges

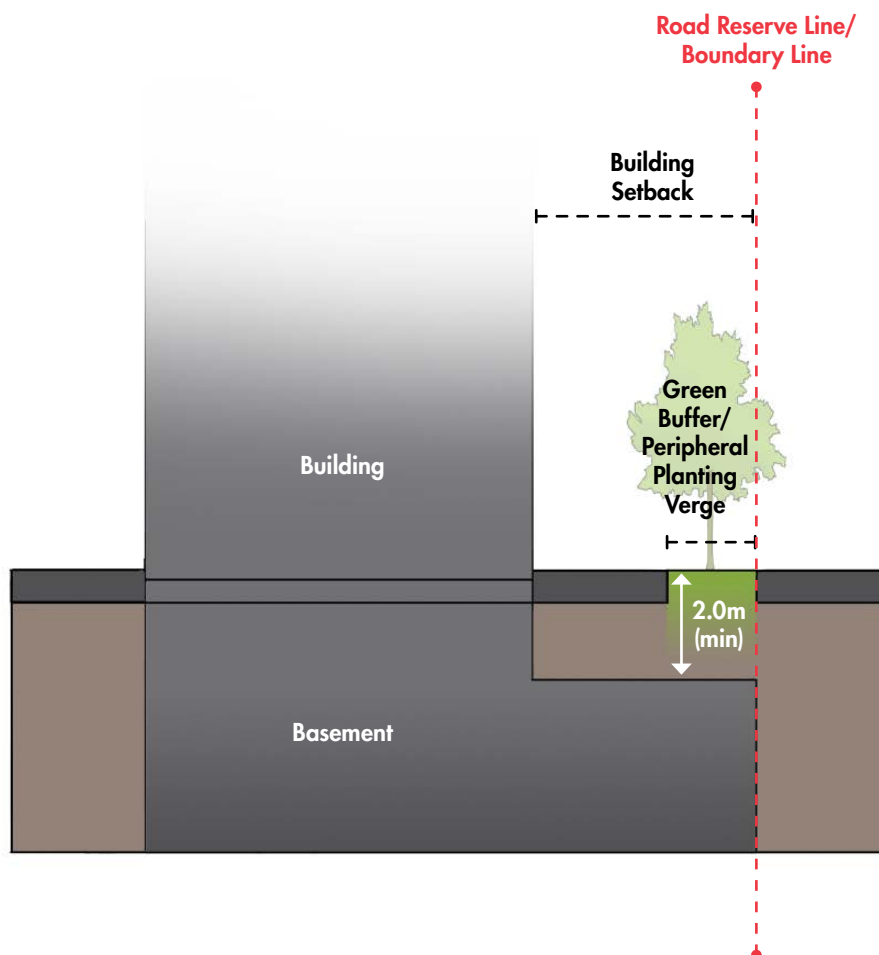

Allowable Structures within Green Buffers and Peripheral Planting Verges

- a. Green buffers and peripheral planting verges should be free from any encroachment, except for allowable minor ancillary structures and landscaping structures as listed in the following table.

Structures allowed within Green Buffers and Peripheral Planting Verges

S/No	Structures	Remarks
1	Flag poles	Installed on individual recessed footings
2	Lamp posts	-
3	Guard house/ Sentry post	Additional provision of toilet and resting facilities should be sited outside of the green buffer area
4	Bin point	Bin centres are not allowed
5	OG boxes	-
6	Water bulk meter	-
7	Inspection chamber & minor sewer lines	Minor sewer lines laid parallel to the development boundary within the green buffers and peripheral planting verges must be recessed at least 2.0m below ground level
8	Underground services	Services laid parallel to the development boundary within the green buffers and peripheral planting verges must be recessed at least 2.0m below ground level Services traversing perpendicularly across the green buffers and peripheral planting verges do not need to be recessed at least 2.0m below the ground level
9	Fire hydrant	-
10	Entrance gate/post	-
11	Metering compartment	-
12	Development permanent signage	Integrated with landscaping and does not interfere with roadside tree planting

Landscape Features allowed within Green Buffers and Peripheral Planting Verges

S/No	Structures	Remarks
1	Garden furniture, e.g. landscape light fittings, benches	<ul style="list-style-type: none"> Open-sided, not enclosed
2	Trellis	<ul style="list-style-type: none"> Not too big in size
3	Water features	<ul style="list-style-type: none"> Contribute to landscaping efforts and generally enhance greenery provision

- b. For any given side of the development, the length of each allowable structure must not exceed 3.0m or their combined length must not exceed 25% of the length of the green buffer or peripheral planting verge along that side, whichever is greater.

Illustrations for Allowable Structures within Green Buffers and Peripheral Planting Verges (Diagrammatic Sectional View)

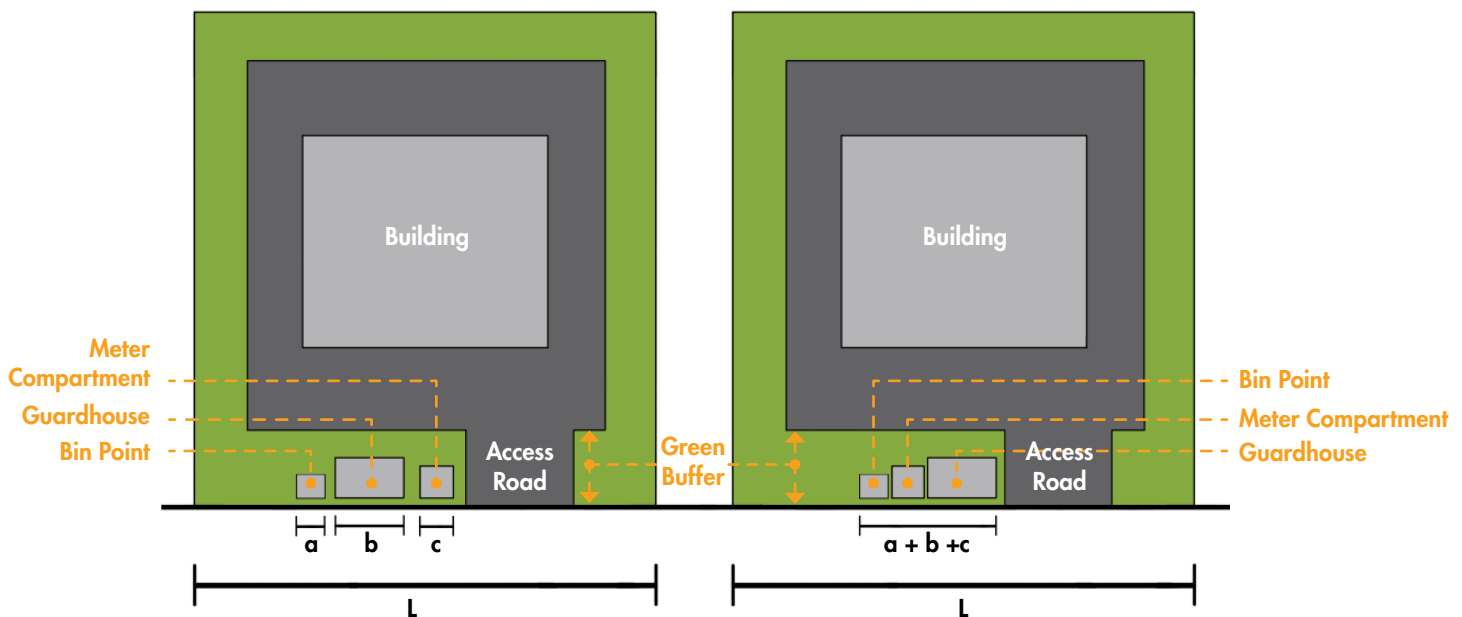

Note:

L includes ingress/egress as these are deemed as essentials for all developments. Total available frontage will be reduced if the ingress/egress is excluded.

a, b, and c refer to examples of allowable structures within planting areas. They must each not exceed 3.0m in length or their combined length must not exceed 25% of the length, L.

Calculation for Allowable Structures

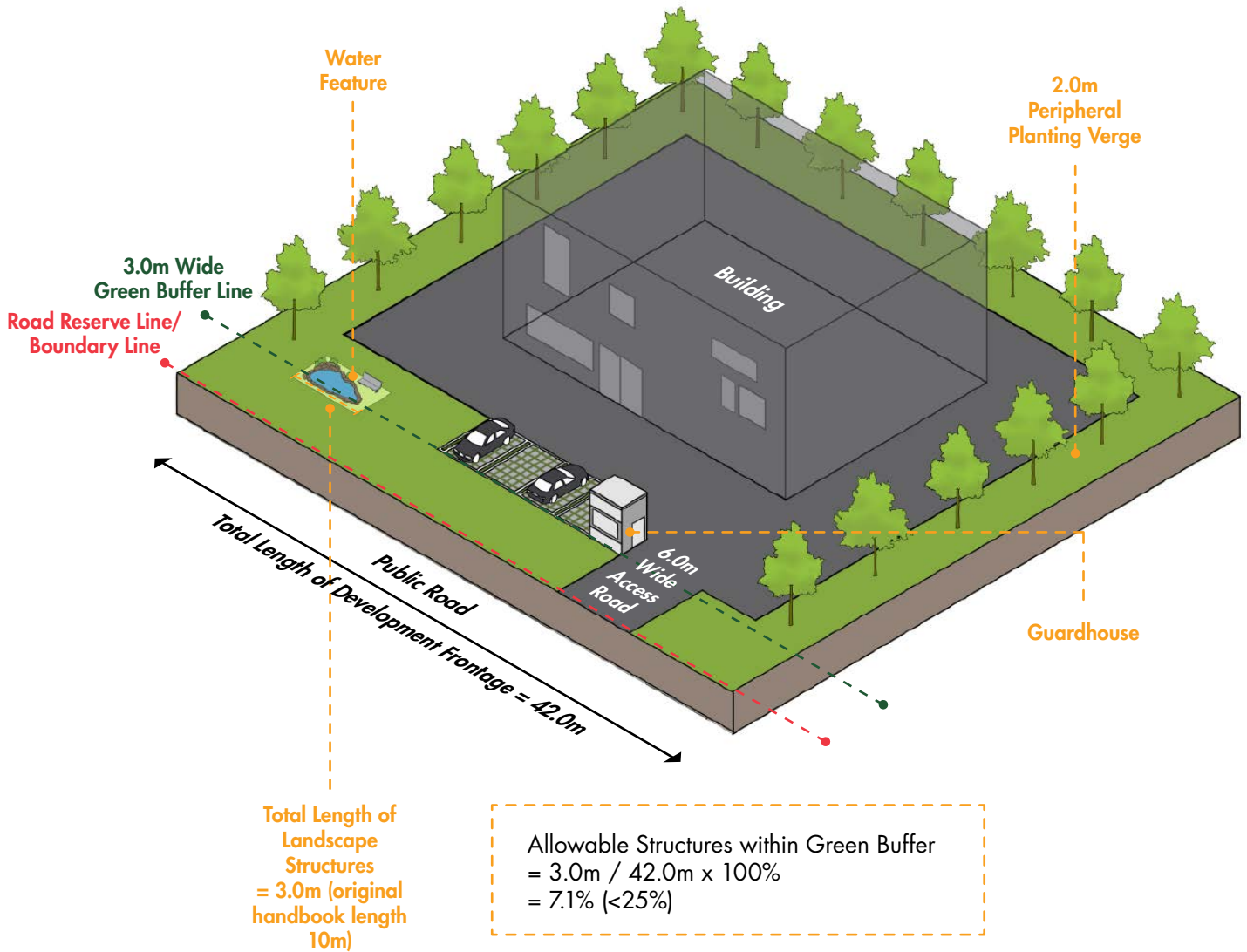

- c. Allowable landscaping structures should contribute toward the landscaping efforts, and can be well-integrated with the provision of trees planted within the green buffers or peripheral planting verges.

Good Examples of Landscape Features in Green Buffers and Peripheral Planting Verges



Garden Furniture



Guard House



Development Signage



Water Bulk Meter

d. Allowable structures above ground should generally be screened with landscaping.

Examples of Allowable Structures in Green Buffers and Peripheral Planting Verges that could be enhanced with Landscaping



Bulk Water Meter



Water Feature

Planting Provision Abutting/Adjacent Internal Driveways

For public building development (e.g. public housing estates, government schools, military camps), in addition to green buffers and peripheral planting verges, a minimum 2.0m wide tree planting verge is to be provided on at least one side of the proposed internal driveway if the driveway does not abut the green buffers or any of the peripheral planting verges.

The 2.0m wide tree planting verge should generally be flat to the ratio of 1:40. If site situation does not permit, the proposed slope should not be steeper than the ratio of 1:2.5.

This 2.0m wide tree planting verge should be free from encroachment, above and below the ground level.

Basement structure below any planting verges must be recessed at least 2.0m below ground level.

Planting Verge Provided on At Least One Side of the Proposed Internal Driveway



Planting Provision for Open Air Parking Area at Street Level

Introduction

All open air parking areas at street level for vehicular parking must cater for the provision of planting areas for the purpose of tree planting. This is beneficial as trees provide shade, reduce glare and contribute to an overall more pleasant environment.

Requirements

The design of an open air parking area at street level must take into consideration the requirements listed under the following categories.

- a. Planting provision
- b. Landscaping

Planting Provision

- a. A minimum 2.0m wide planting verge is to be provided along a row of parking lots, if the parking area does not abut to the green buffer or any of the 2.0m wide peripheral planting verges.
- b. A minimum 4.0m wide planting verge (centre divider) is to be provided between two rows of parking lots.
- c. A minimum 4.0m wide planting verge is to be provided between a building and parking lots.
- d. The planting verges should generally be flat to the ratio of 1:40. If site situation does not permit, the proposed slope should not be steeper than the ratio of 1:2.5.
- e. All planting verges should be free from encroachment, above and below the ground level.
- f. Basement structure below any planting verges must be recessed at least 2.0m below ground level.

Note:

- The provision of the planting verge is not required for parking lots within residential landed housing developments
- The provision of the planting verge is exempted for loading/unloading bays.

Planting Provision Guideline for Open Air Parking Area at Street Level (Not to Scale)



Alternative Planting Area Configuration for Open Air Parking Area at Street Level

For developments with considerations such as technical constraints or with special design intents, alternative configurations for the planting verges can be considered on a case-by-case basis. For example, the tree planting area can be placed in-between parking lots or combined with planting verge along the row of parking lots.

Such configuration must fulfil the following conditions:

- a. Total configured planting area shall not be less than the total original planting area required for the number of parking lots provided; and
- b. Planting areas, designated for trees to be planted up to a maximum spacing of three lots width for angled parking or two lots length for parallel parking, must have a minimum 2.0m clear width; and
- c. All other planting area, if provided, shall keep a minimum clear width of at least 1.0m.

Note:

To cater for the space needed for the crown spread of a tree to the building façade, planting area designated for tree planting abutting to a building should maintain a minimum planting space of 4.0m from the building line.

Refer to the following scenarios as examples for alternative planting area configuration.

Examples of Parking Lots Planting Area Provision which Fulfil the Conditions for Alternative Configuration (Not to Scale)

A. Single Row of (Angled) Parking Lots

For standard planting area provision, a planting area of 24 sqm will be required along a row of five parking lots.

Example 1
Total configured planting area (24 sqm)
= Original planting area provision



Example 2
Total configured planting area (25.9 sqm)
≥ Original planting area provision



Examples of Parking Lots Planting Area Provision which Fulfil the Conditions for Alternative Configuration (Not to Scale)

A. Single Row of (Parallel) Parking Lots

For standard planting area provision, a planting area of 54 sqm will be required along a row of five parallel parking lots.

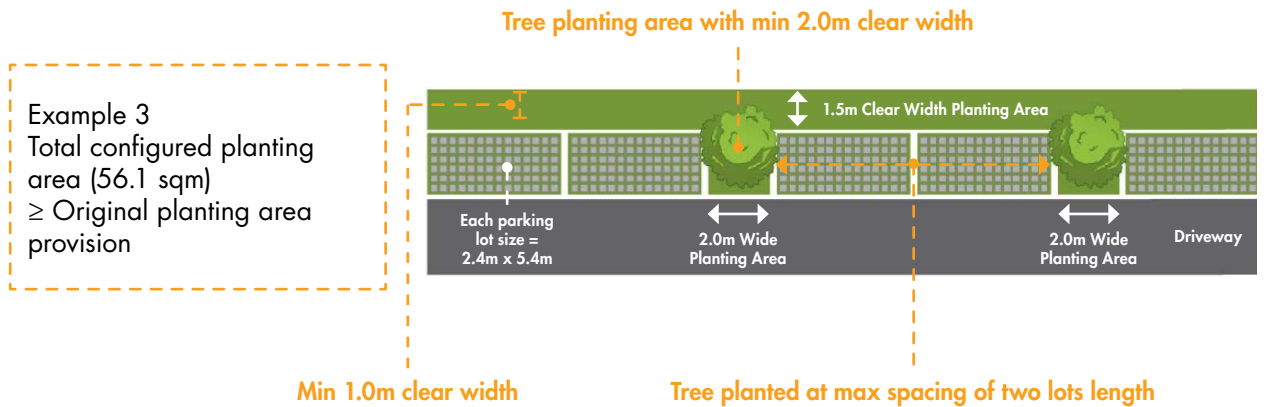

B. Between Two Rows of Parking Lots

For standard planting area provision, a planting area of 48 sqm will be required between two rows of five parking lots.

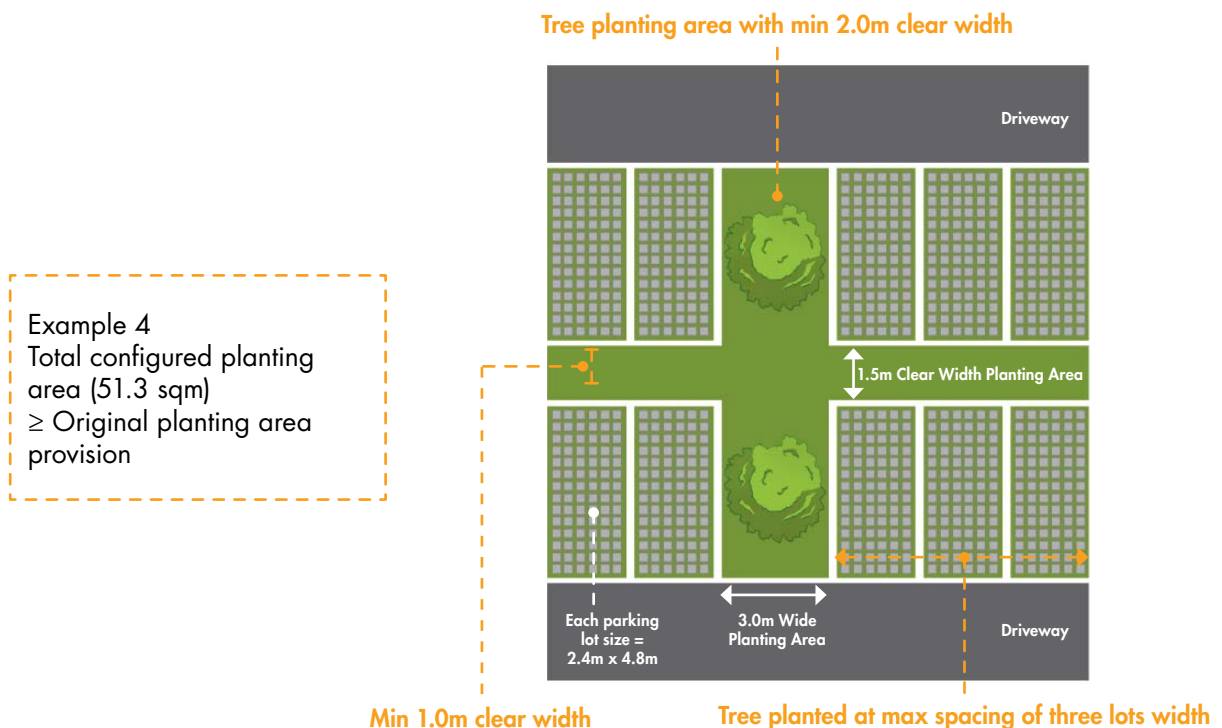

C. Between a Row of Parking Lots and a Building

For standard planting area provision, a planting area of 48 sqm will be required between a row of five parking lots and the building.

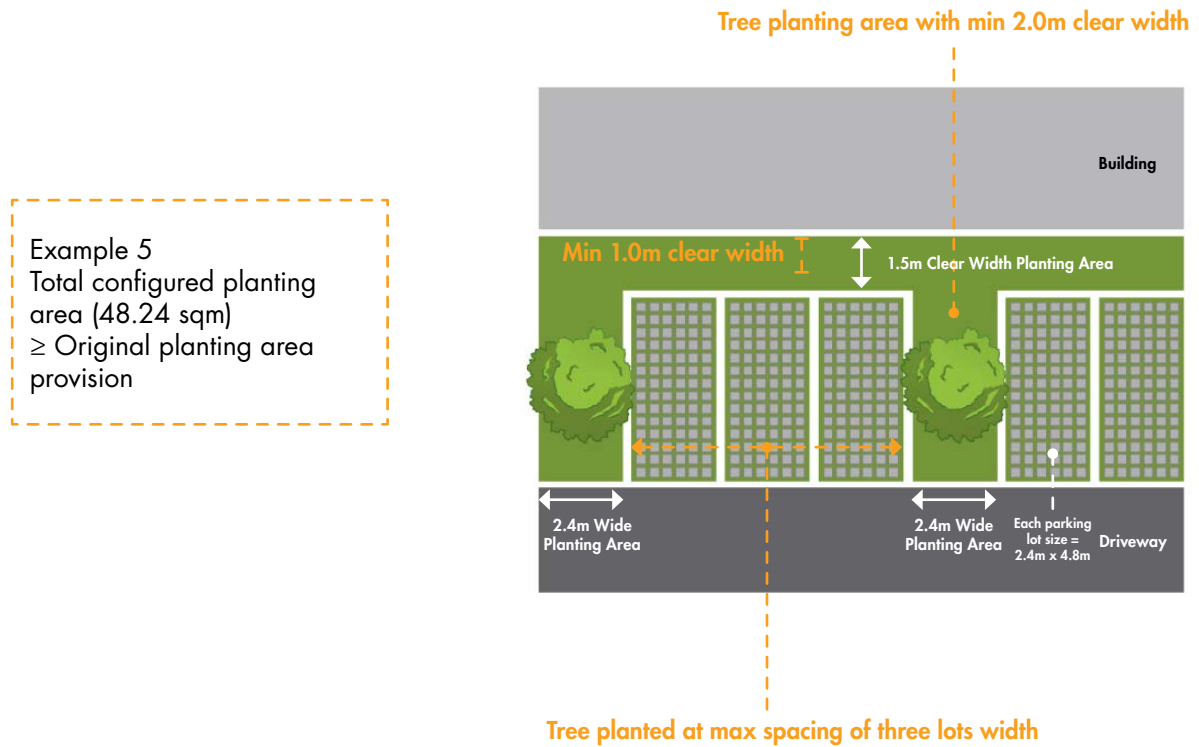

Planting Provision for Sheltered Parking Lots at Street Level

- a. The requirements for planting provision specified under Chapter 3, **Planting Provision for Open Air Parking Area at Street Level** are also applicable for parking lots sheltered by standalone structures or by building an extension*. (refer to Figure 1 for some examples of such planting area provision)
- b. For developments with special design intent for an extension* from building to shelter over the directly adjacent parking lots, based on the extent of area covered, the planting area provision must fulfil the following conditions:
 - If more than half (>50%) of the parking lots area is under the shelter, the restricted planting area shall be replaced with a green roof system and/or trellis planting considered on a case-by-case basis with:
 - i. Provision of suitable planting medium to support a sustainable green roof or trellis planting.
 - ii. Planting is to be established and provide a full green cover over the shelter.
 - iii. Maintenance access provided should meet Work-at-Heights (WAH) regulations.
 - If less than half (<50%) of the parking lots area is under shelter, planting area(s) designated for trees to be planted up to a maximum spacing of three lots width for angled parking can be placed between the parking lots and must have a minimum 2.0m clear width. The total configured planting area shall not be less than the total original planting area required between the row of open air parking areas at street level and the building. You may refer to Figure 2 for an example of such alternative planting area provision.
- c. Planting provision is exempted for parking lot with more than half (>50%) of its area within the building. (refer to Figure 3 for illustration)

Note:

*Extension refers to permanent structure(s) from the building such as building canopy or roof fixture.

Figure 1
Examples of Parking Lots Planting Area Provision for Sheltered Parking Lots
(Not to Scale)

A. Standalone Shelter for Row of Parking Lots Adjacent to Building

For standard planting area provision, a planting area of 48 sqm will be required between a row of five parking lots and the building.



Tree planting area with min 2.0m clear width

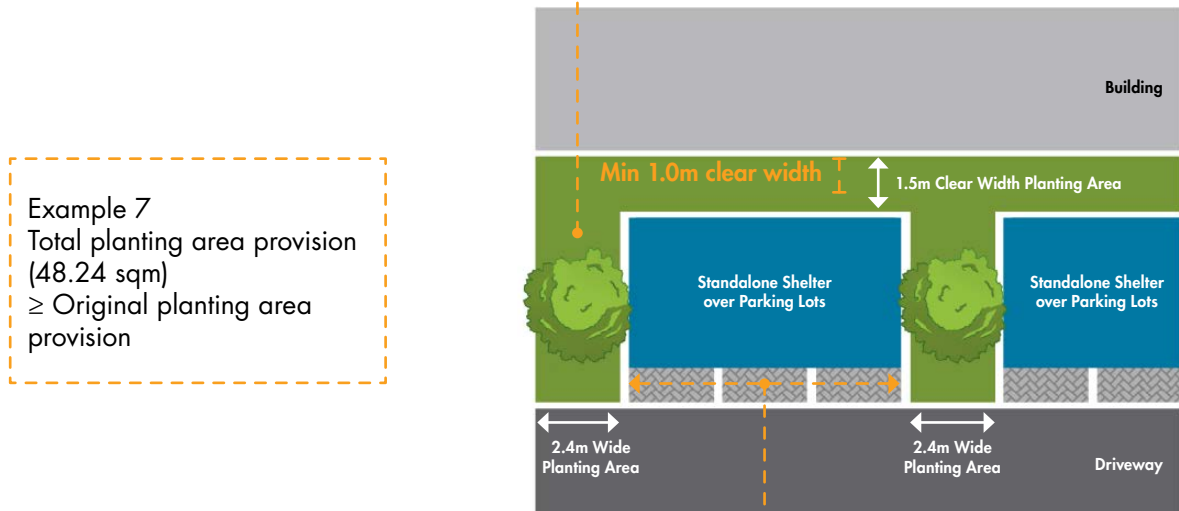

Tree planted at max spacing of three lots width

B. Building with Extension of Shelter Covering less than Half of Parking Lot Area

For standard planting area provision, a planting area of 48 sqm will be required between a row of five parking lots and the building.

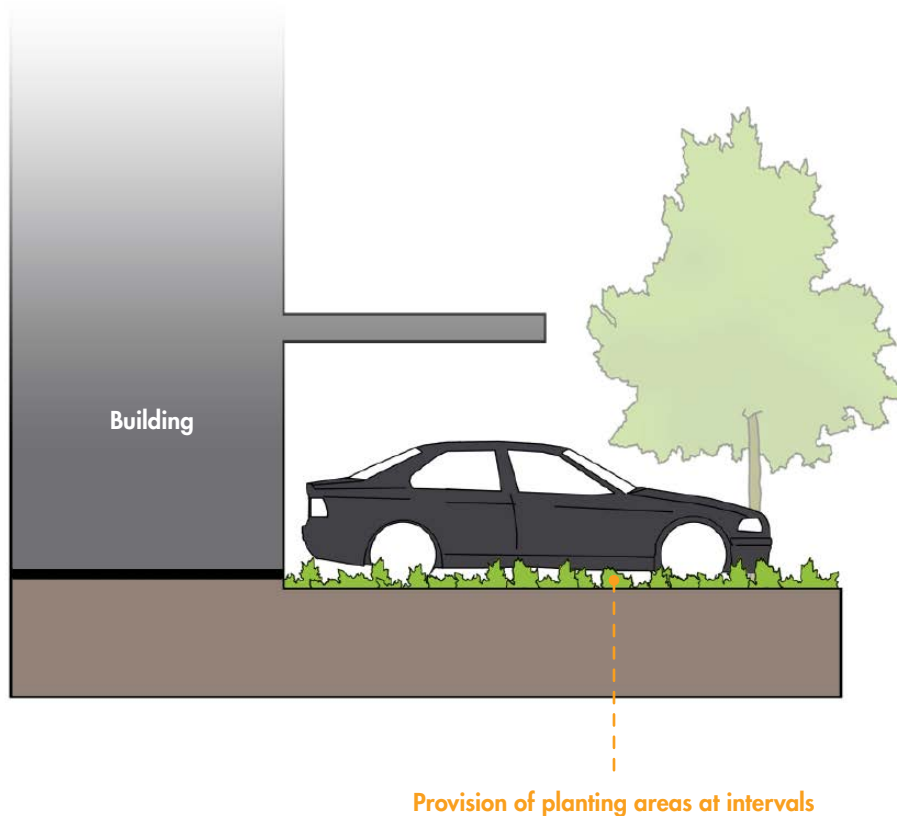

Figure 2
Examples of Parking Lot with at least half of the Area Covered by Extension of Shelter from the Adjoining Building (Not to Scale)

The standard parking lots planting area provision shall be converted to a green roof system or trellis planting system on the building extension or permanent roof fixture with a full green canopy and maintenance access.

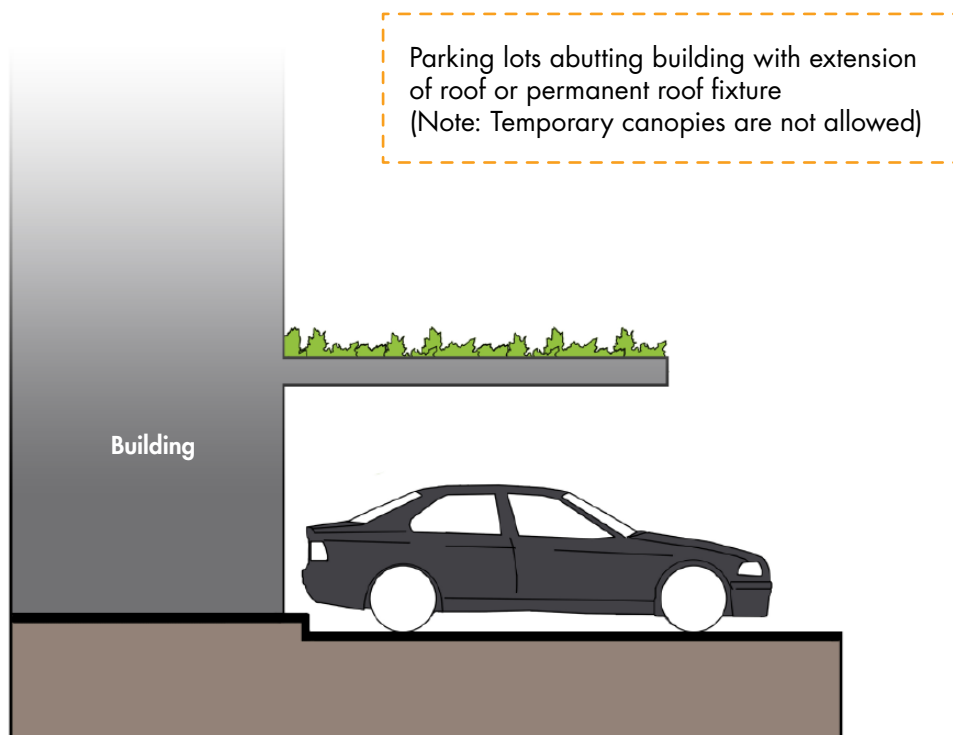
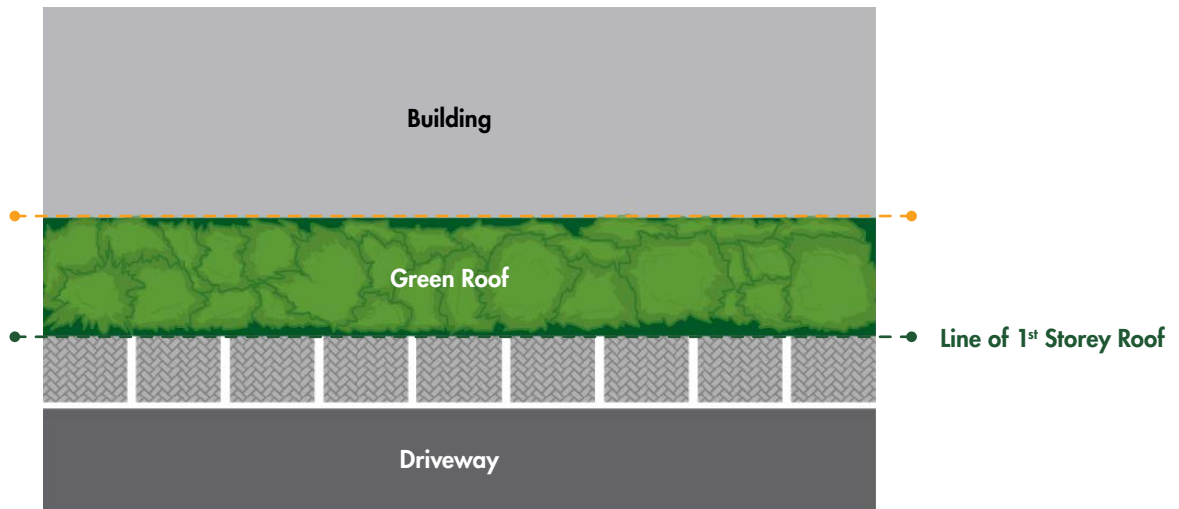
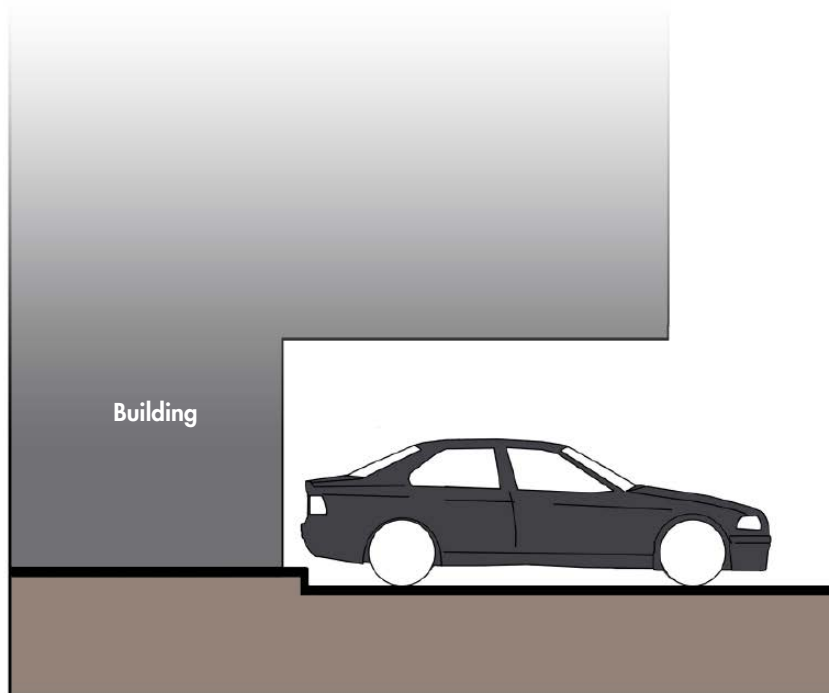

Figure 3
Example of Parking Lot with more than half (>50%) of the Parking Lot Area under or within Building (Not to Scale)

The standard planting area provision for open air parking area at street level is not required for parking lots with more than half of its area within a building.



Tree/Shrub Planting for Parking Lots

Introduction

The gentle beauty of trees and shrubs goes beyond beautifying our urban environment aesthetically. Trees remove carbon dioxide from the atmosphere, increase biodiversity in the urbanised environment of Singapore and readily hold water that could cause soil erosion and/or flash floods, as well as provide shade and lower the atmospheric temperature. The value of tree, shrub and greenery provision has been shown to create measurably healthier people and help in the development of better social relationships when people are surrounded by greenery. Visual exposure to trees and nature is also known to reduce stress levels in our fast-paced society.

A list of suggested trees and shrubs is available to help developments make choices towards a more enhanced landscape within the facility.









































- a. Tree species can be selected from the following table. It is advisable for the choice of alternative tree species to have a rounded or spreading crown habit to maximize the benefits of tree planting as introduced above.

Suggested Trees for Open Air Parking Area at Street Level

S/No	Species	Approximate Height When Mature (m)
1	<i>Samanea saman</i> (Rain Tree)	25
2	<i>Hopea odorata</i>	25
3	<i>Filicium decipiens</i> (Fern Tree)	24
4	<i>Michelia alba</i> (White Chempaka)	22
5	<i>Milletia Chempaka</i>	22
6	<i>Pouteria obovata</i>	20
7	<i>Pteleocarpa lamponga</i>	20
8	<i>Dalbergia latifolia</i>	15
9	<i>Neolitsea zeylanica</i>	15
10	<i>Ilex cymosa</i>	12
11	<i>Lagerstroemia speciosa</i> (Rose of India)	12
12	<i>Xanthostemon chrysanthus</i>	12
13	<i>Brachychiton acerifolius</i>	12
14	<i>Cratoxylum cochinchinensis</i>	12

- b. Shrubs species can be selected from the following table. It is advisable to allow shrubs to grow to a height of around 1.0m so that surface harshness, such as for large parking areas, can be visibly softened with flowering shrubs and greenery. For areas where line-of-sight may pose a safety concern, the shrub planting is required to be maintained at a lower height.

Suggested Shrubs for Open Air Parking Area at Street Level

S/No	Species	Shade Tolerant	Flowering	Fragrant	Drought Tolerant
1	<i>Acalypha hispida</i>				
2	<i>Aglaia odorata</i>				
3	<i>Bridelia ovata</i> (variegated)				
4	<i>Caesalpinia pulcherrima</i>				
5	<i>Duranta spp.</i> (except dwarf cultivar)				
6	<i>Excoecaria cochinchinensis</i>				
7	<i>Galphimia glauca</i>				
8	<i>Gardenia tubifera</i>				
9	<i>Hamelia patens</i>				
10	<i>Ixora spp.</i> (except dwarf cultivar)				
11	<i>Jasminum sambac spp.</i>				
12	<i>Murraya paniculata</i>				
13	<i>Mussaenda spp</i>				
14	<i>Osmanthus fragran</i>				
15	<i>Pandanus amaryllifolius</i>				
16	<i>Phyllanthus myrtifolius</i>				
17	<i>Pseuderanthemum carruthersii</i>				
18	<i>Schefflera arboricola</i> (variegated)				
19	<i>Senna surrattensis</i>				
20	<i>Stachytarpheta indica</i>				
21	<i>Tecoma capensis</i> 'Aurea'				
22	<i>Thunbergia erecta spp.</i>				
23	<i>Wrightia antidysenterica</i>				
24	<i>Wrightia religiosa</i>				

Hedges Planting for Proposed Bin Centre and Electrical Substation within Development Premises

A minimum of 1.0m wide planting verge is to be provided for planting of hedges around bin centres and substations of public building development as shown in the following illustration. This is applicable to Public Building Developments.

Photo of Electrical Substation with Hedges as Peripheral Planting



Hedges Planting for Government Schools

Hedges are required to be planted along the perimeter fence of government schools to enhance development greenery and to soften the mesh fencing wall.

Hedges Planting along Perimeter Fence of Government School



Planting Scheme at Building Plan Stage

Planting Scheme is to be submitted at the Building Plan stage for development projects submitted to NParks before 1 September 2020, and at Development Control stage for those submitted to NParks on or after 1 Sep 2020. It is only applicable to the following development types, or as specified by NParks:

- a. Public buildings (excluding HDB developments)
- b. Government schools
- c. Good class bungalows within a TCA or vacant land
- d. Apartments within a TCA or on vacant land
- e. Condominium developments within a TCA or on vacant land
- f. Cluster housing development within a TCA or on vacant land
- g. All business 1, business 2 and business parks development
- h. Open-air parking lots at street level
- i. Electrical sub-stations

For submission of planting scheme, please refer to Chapter 8, **Submission Procedures**.

4 GREENERY PROVISION FOR ROADSIDE

Singapore has an extensive roadside greenery that forms the backbone of our City in Nature. With the pervasive planting of trees along the roadside, these trees provide shade for pedestrians and create a pleasant environment for all. Over the decades, NParks has also introduced colourful and flowering plant species, as well as multi-tiered planting of trees and shrubs, to enable biodiversity to take root and flourish, and making our city more vibrant and livable.

Technical Requirements for Roadside Greenery Provision

Provision for Green Verge

Green verge is the area along the centre median or side of a road, or a traffic island within a road, which is provided for the growing of trees and other plants. When the green verge is along the side of a road, it usually consists of a tree planting verge and service verge. The make-up of the green verge should be in accordance with the LTA's code of practice and standards. Where there is no requirement from LTA to provide and implement the standard road elements, the width of the green verge should minimally match that of existing site conditions.

Illustration of a Standard Roadside Table

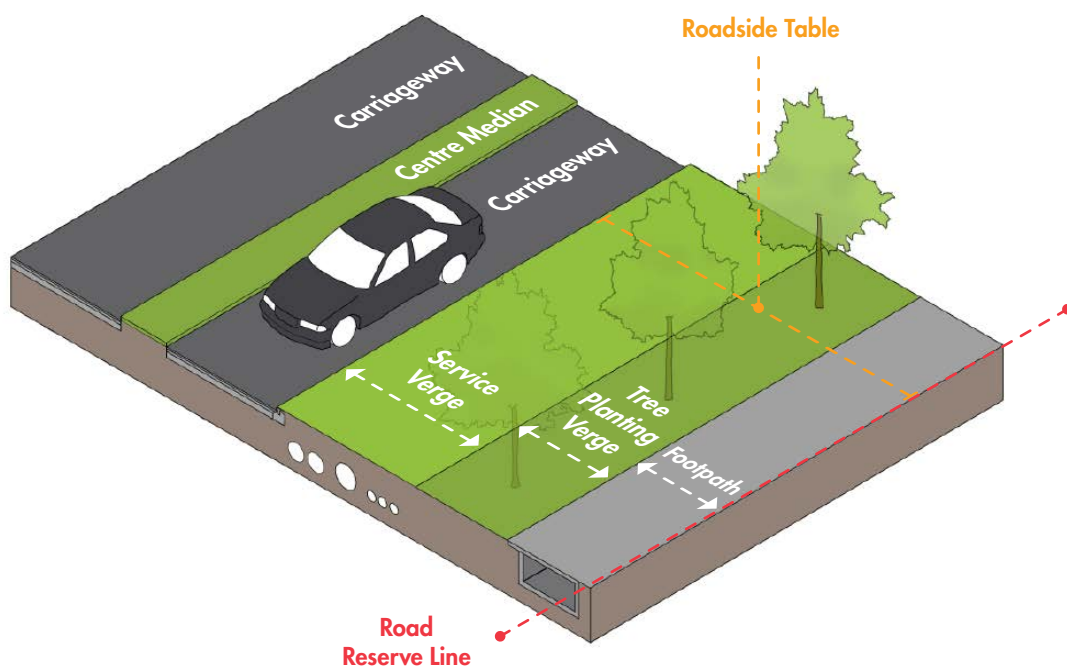

Proposed Green Verge for New and Existing Roads

a. Refer to the following table and illustration for the requirements for proposed green verge.

Requirements for Proposed Green Verge

Soil	Turf	Gradient of Slope
<ul style="list-style-type: none"> • Minimum 2.0m soil depth • Top layer (1.0m depth of approved soil mixture) • Bottom layer (1.0m depth soil) • There should not be any hard-core or construction debris within the backfill soil/material for the green verges 	50mm thick <i>Axonopus compressus</i> (cow grass) in close turving	Generally to be flat (1:40). The finished soil level of the verge is to be 25mm below the footpath

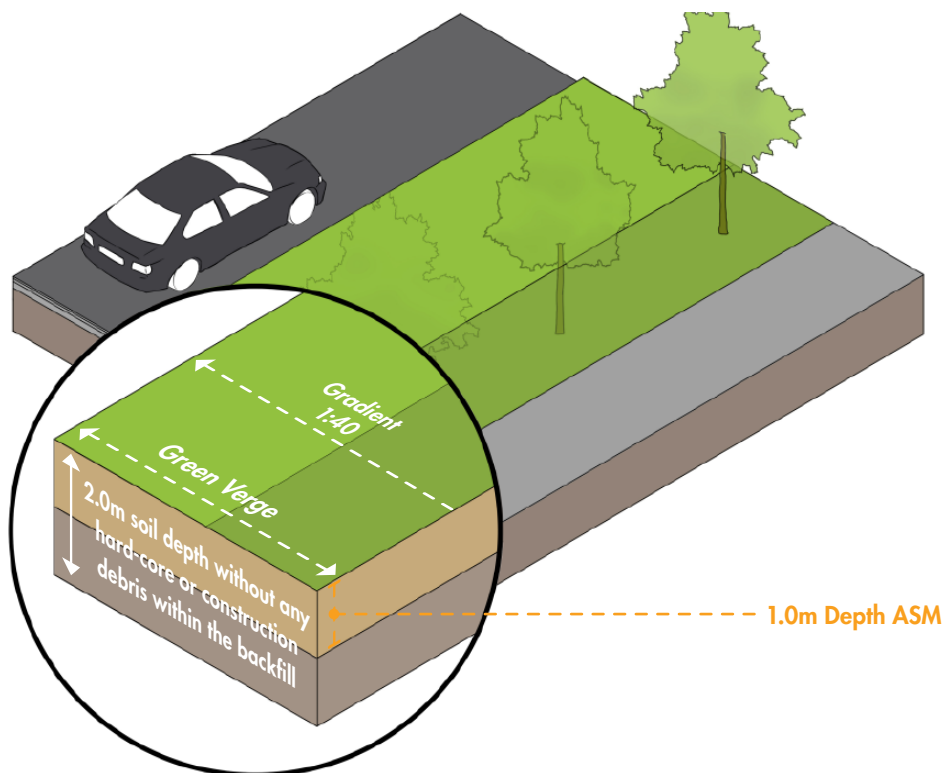

- b. Length of a planting island between a paired access point of adjoining units should be at least 6.0m in length.

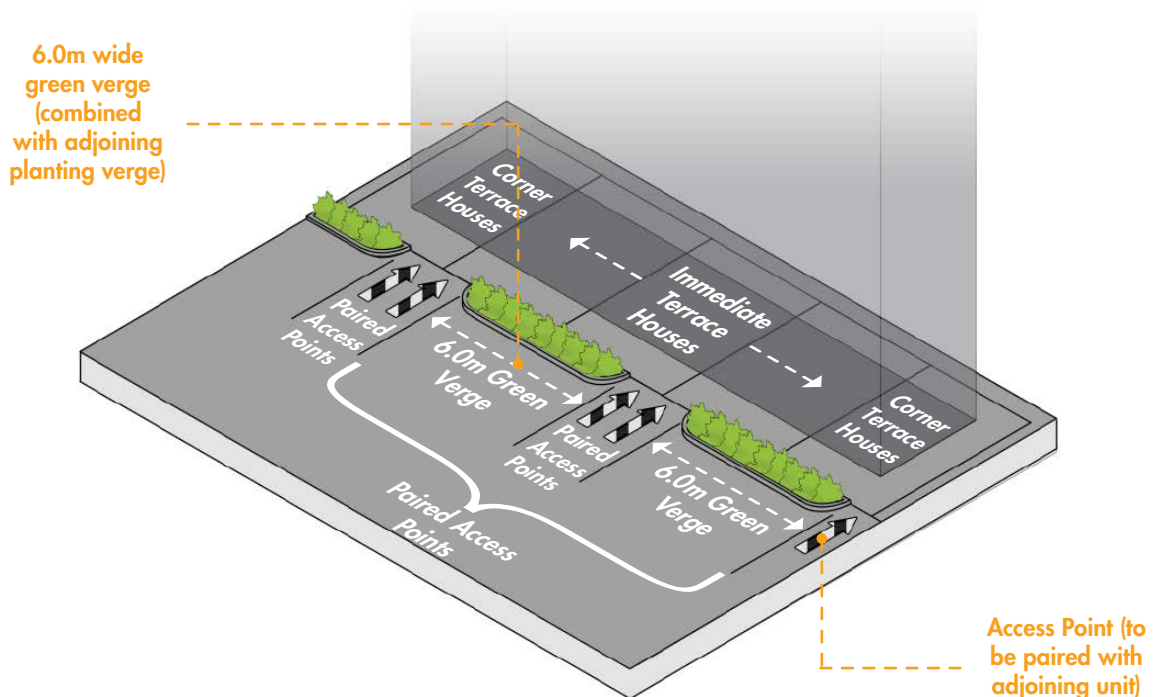

- c. Proposed green verges of less than 0.5m wide or less than 1.0m² should be paved to match with the adjacent footpath.

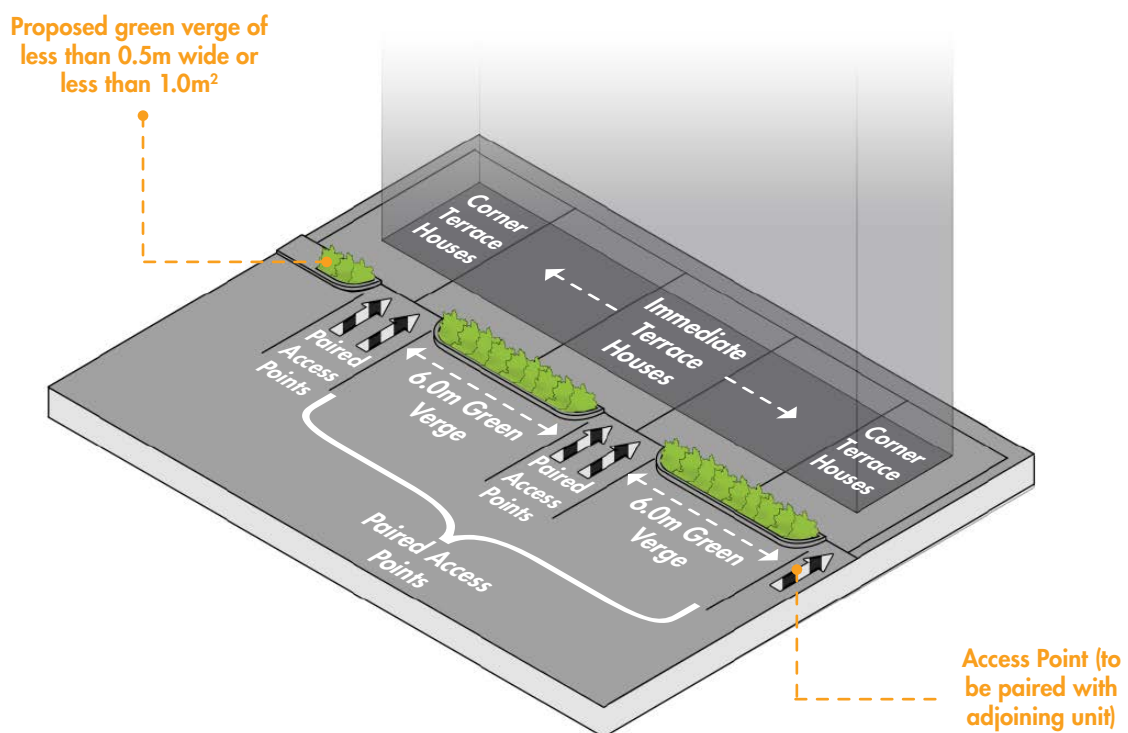

- d. In upgrading projects where the existing open drains are converted into box culvert (i.e. footpath cum drain), the existing footpath should be converted into green verge. Refer to the following illustration.

Existing Footpaths Converted into Green Verge

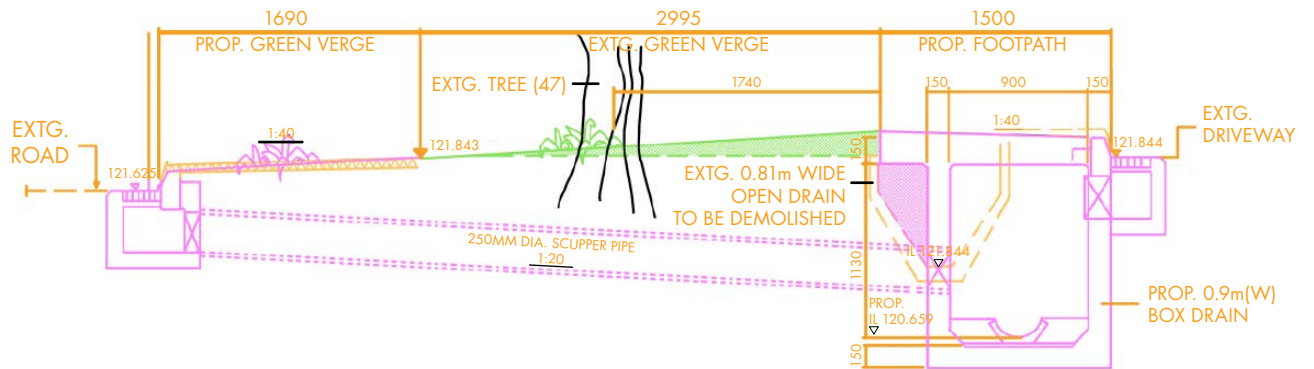

- e. New tree/shrub planting is required for proposed green verge.

Disturbed Green Verge for Existing Roads

- a. Refer to the following table and illustration for the reinstatement requirements for disturbed green verges.

Reinstatement Requirements for Disturbed Green Verge

Depth of Excavation during Construction	Reinstatement of Soil	Reinstatement of Turf	Gradient of Slope
≥ 1.0m	At least 1.0m depth of approved soil mixture (ASM). There should not be any hard-core or construction debris within the backfill soil/material for the green verges	50mm thick <i>Axonopus compressus</i> (cow grass) in close turfing	Generally to be flat (1:40) The finished soil level of the verge is to be 25mm below the footpath
< 1.0m	Backfill ASM for the entire excavated depth There should not be any hard-core or construction debris within the backfill soil/material for the green verges		

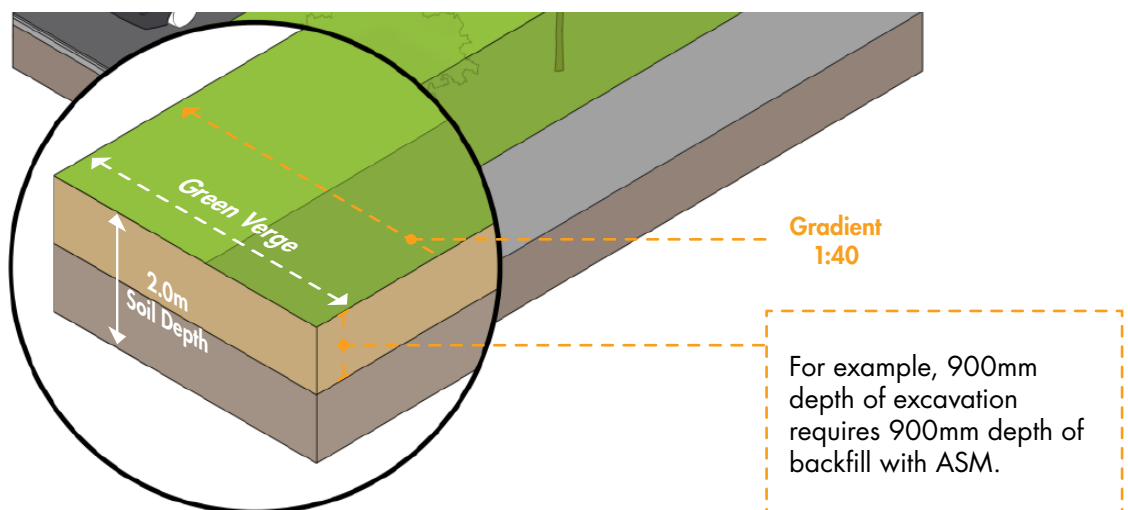

- b. Replacement tree/shrub planting is required for the affected roadside greenery to replace the affected greenery.

Encroachment within Green Verge

- a. Fire engine accessways are not to encroach into the green verges.
- b. No underground services are allowed to be laid within the tree planting verge.
- c. For services that are required to traverse perpendicularly through a tree planting verge into a building plot:
 - They are to be laid at a minimum 2.0m below ground level where possible;

Cross Section showing Underground Services that Traverse across Green Verge

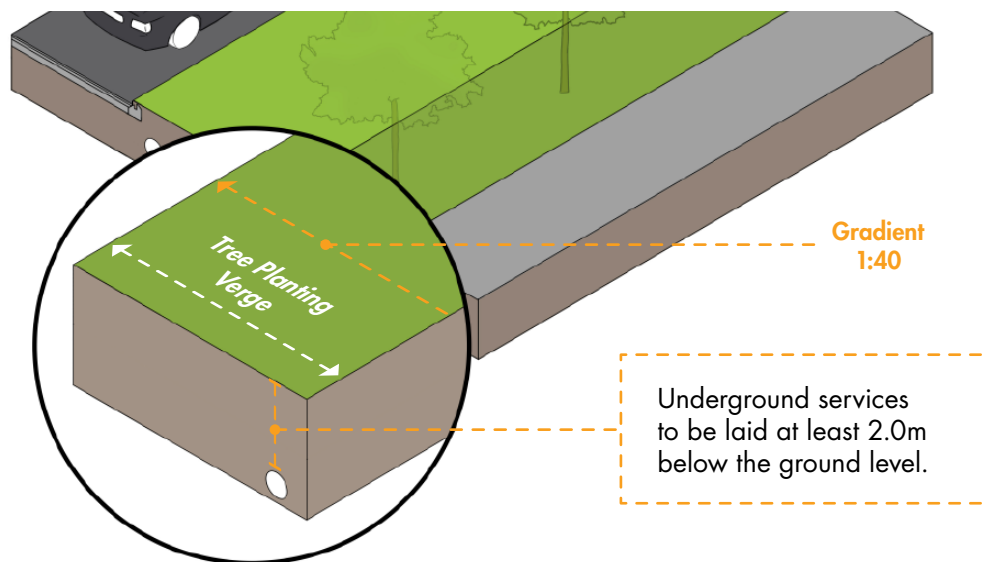

- They are to be laid at least 2.0m away from the centre of a tree/palm. Dependent on the root spread, especially for trees with girth of more than 2.0m, a wider clearance may be required as determined on a case-by-case basis.

Clearance of Underground Services from the Centre of a Tree/Palm

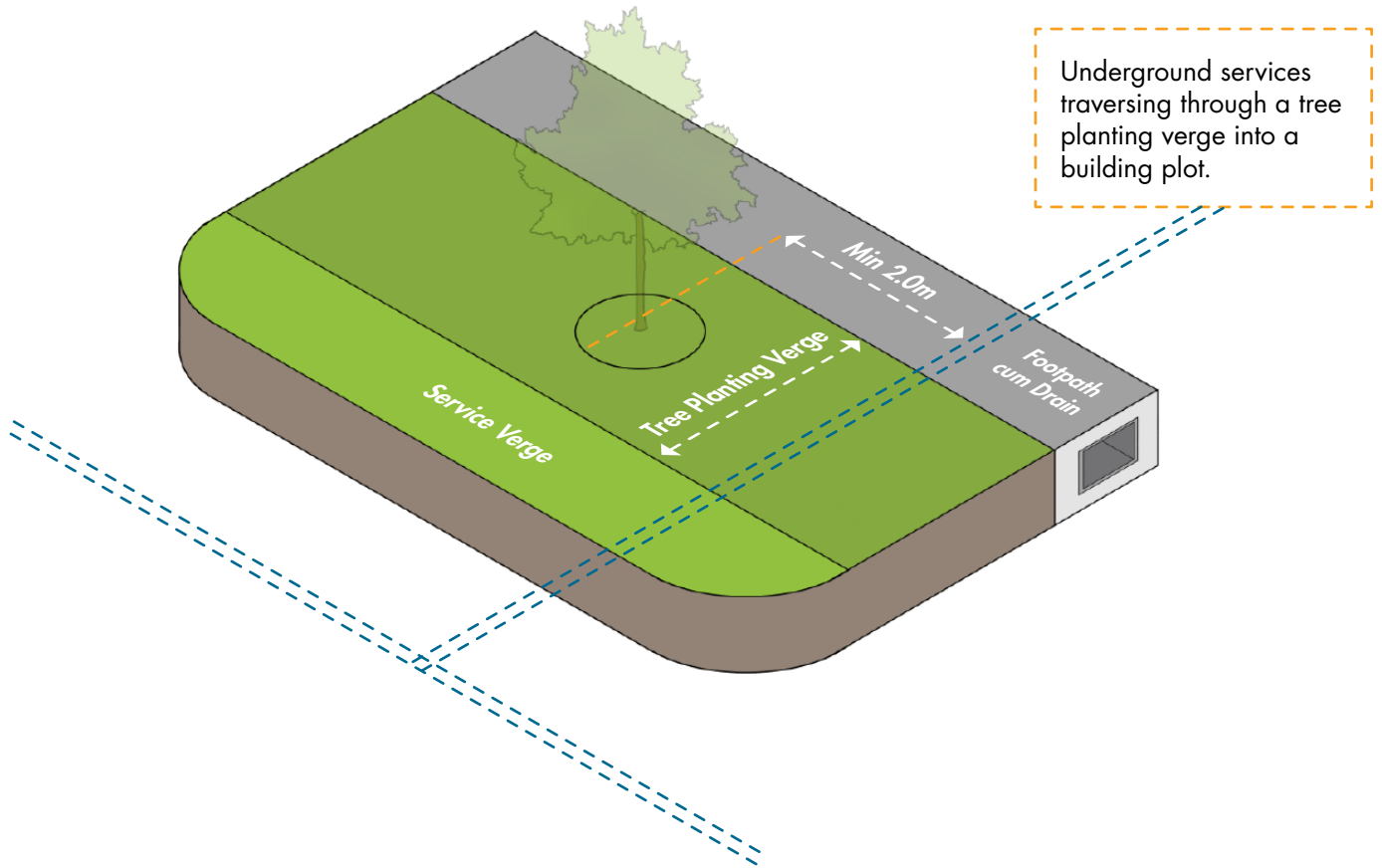

Soil Specifications of Green Verges

Soil is a vital component of the green verges, as it contains the nutrients, water and air that are needed by trees and plants to grow healthily. It serves as the medium for root anchorage and provides for tree stability. Hence, the quality of the soil is essential.

To ensure good and consistent quality of soil within the green verges, approved soil mixture (ASM) must be used. The component of the ASM shall be in the ratio 3:2:1 of loamy soil, compost and washed sand, respectively. The proportions are by volume.

Specifications for Approved Soil Mixture (ASM)

Parameters	Required Range/Value
pH	5.5–7.5
Electrical Conductivity	Less than 2.0 dS/m
Organic Matter	Minimum 10% by dry weight
Cation Exchange Capacity	Greater than 10meq/100g soil by dry weight
C:N Ratio	Less than 25:1 but below 12:1
Bulk Density	Greater than 0.8Mg/m ³
Permeability	Unsaturated hydraulic conductivity 50 - 100 cm/h
Heavy Metal Concentration	No sewage sludge to be used in preparation of compost or mulch
Organic Contaminants	To comply with national standards under public health and pollution control, whenever such standards are applicable
Pathogens	Fecal coliforms, 1000 MPN per g total solids

To ensure that the quality of the planting mixture conforms to NParks' standard for ASM, NParks may conduct a physical check of the soil at the Certificate of Statutory Completion (CSC) stage. As a self-check measure, we strongly encourage developer/owner to do a laboratory test of the soil prior to backfilling of the roadside green verge to ascertain the quality of the soil. For more information, please refer to **Chapter 7 Certificate of Statutory Completion**.

Planting within Green Verges

All green verges are required to be planted with turf, shrubs and trees to provide shade and pervasive greenery. The tree and plant species will be specified by NParks upon submission of development plan, and is dependent on site condition and landscaping theme for the location.

Owners who are interested in planting and maintaining shrubs on green verges fronting their premises are required to make an application to NParks for a planting permit. This is not required for landed housing development. The planting permit application form is available on NParks' website.

Turfing

Axonopus compressus (cow grass) supplied shall be of healthy and vigorous stock. Turf shall be laid abutting (close turfing) with no visible spaces between adjoining turfs. On completion, the turfing shall present a uniform and regular appearance.

The grass or turf shall be 50mm in thickness with provision of at least 100mm depth planting mixture comprising 3 parts of loamy soil, 2 parts of compost and 1 part of washed sand. (refer to Chapter 5 on the Section under **Turfing**)

Tree Planting for Tree Planting Verges $\geq 2.0\text{m}$ Wide

For tree planting verges that are more than or equal to 2.0m wide, proposed trees should be planted at 1.0m away from the edge of the footpath.

Tree Planting for Tree Planting Verges $\geq 2.0\text{m}$ Wide

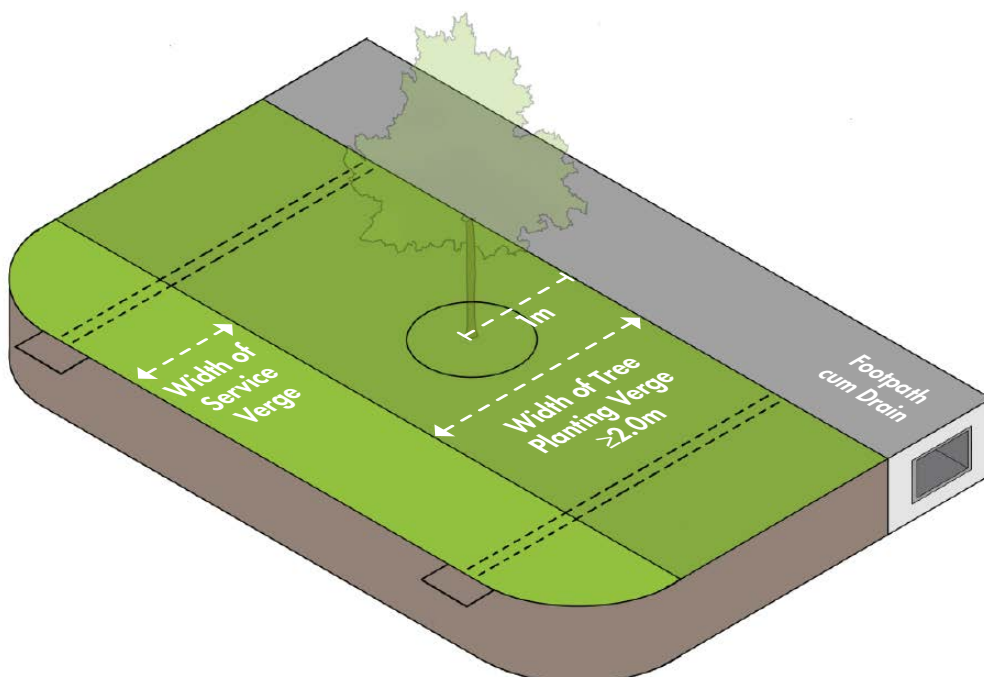

Tree Planting for Tree Planting Verges <2.0m Wide

For tree planting verges that are less than 2.0m wide, proposed trees should be planted at the midpoint of the tree planting verge. Depending on the width of road reserve, the tree planting verge may be 1.2m, 1.5m or 2.0m wide.

Tree Planting for Verges <2.0m Wide

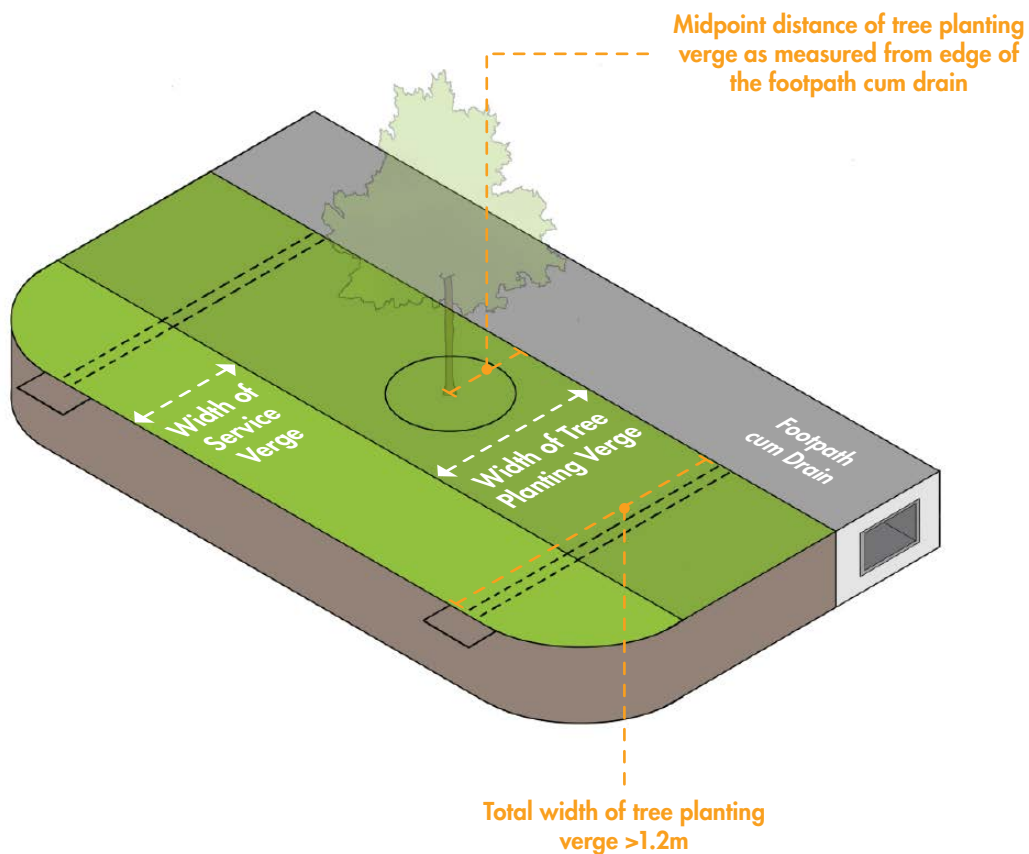

Tree Planting within Existing Footpath (Tree in Footpath)

The aeration provision should comprise a minimum area of unpaved area, with loose paved PC slabs around the tree base that match with the existing ones, or in accordance with the following illustrations.

Tree Planting within Footpath

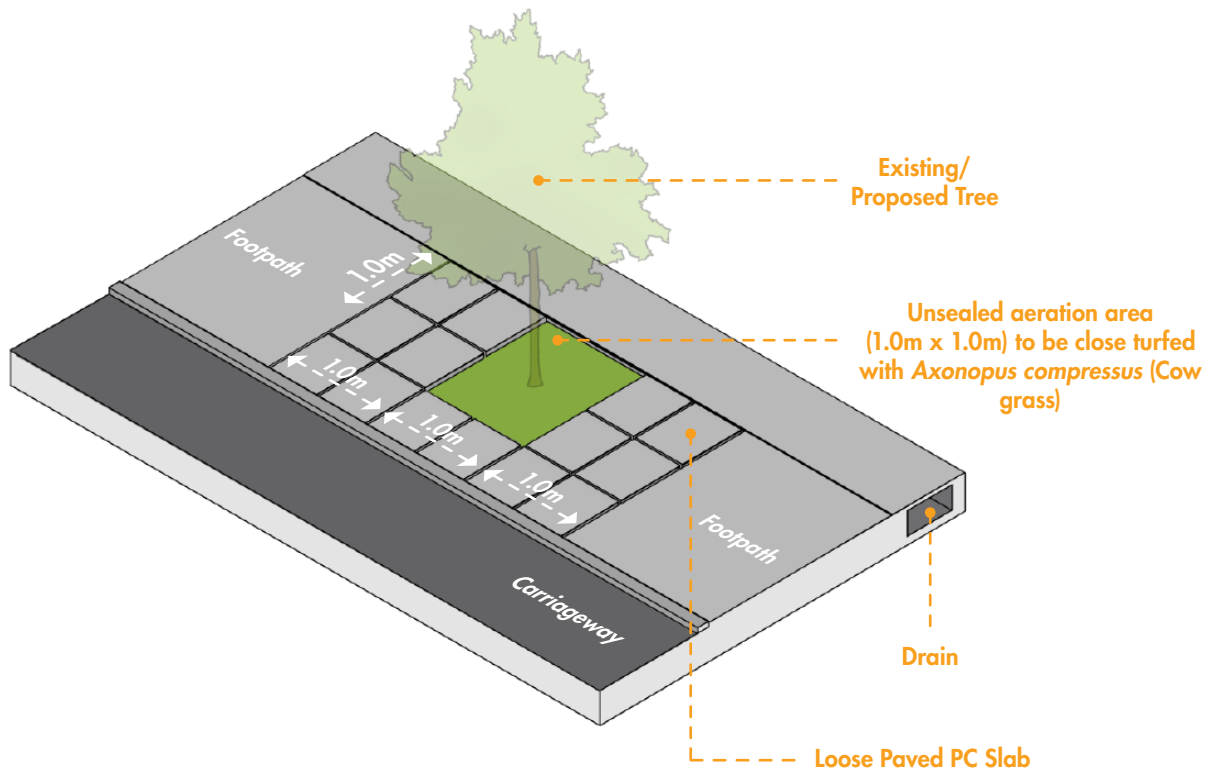

Plaza Planting

Plaza plantings allow integration of trees and shrubs plantings into the urban built environment, reducing ambient temperature, providing visual relief and softening hardscape for pedestrians and users.

a. Tree Planting

If a tree is to be planted on a plaza, an unsealed soil area of at least 2.0m x 2.0m, with a total surrounding aeration area of 16.0m², is to be provided around the tree. Refer to the following illustration for the shape and soil area for plaza planting.

Tree Planting on Plaza

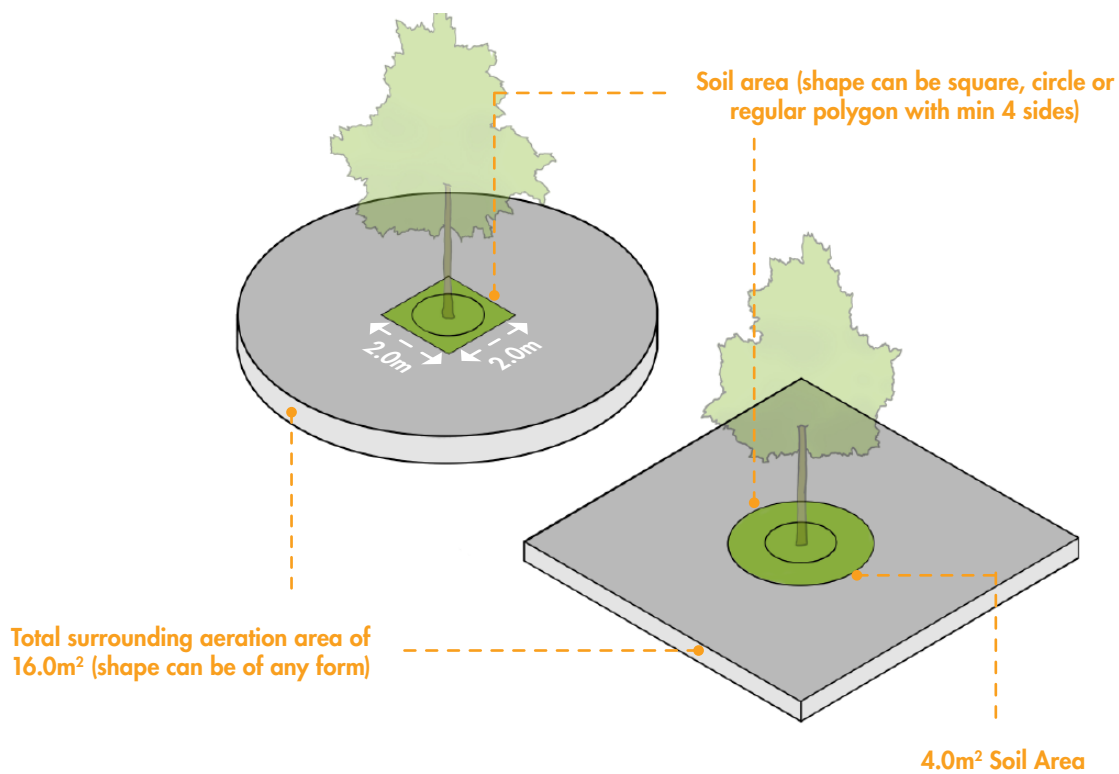

b. Palm planting

If a palm is to be planted on a plaza, an unsealed soil area of at least 1.5m x 1.5m, with a total surrounding aeration area of 16.0m², is to be provided around the palm. Refer to the following illustration for the shape and soil area for plaza planting.

Palm Planting on Plaza

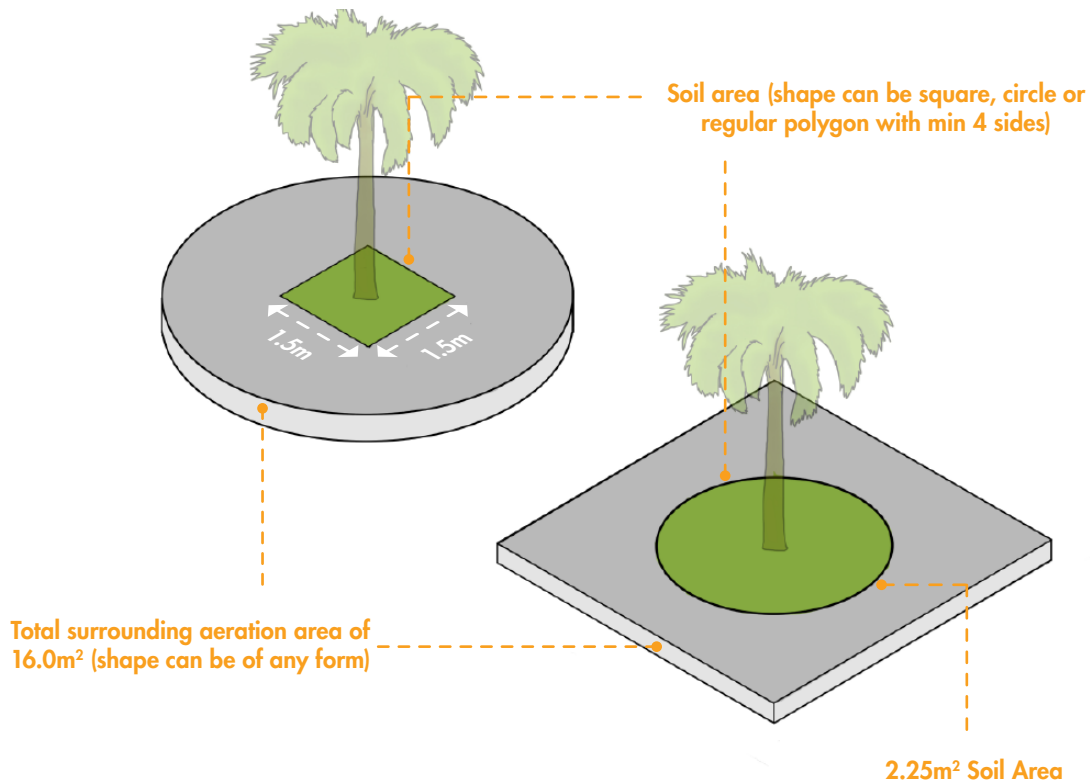

Clearance Distances of Roadside Elements to Trees

The clearance from the edge of a proposed road element to the centre of a proposed tree/palm should be as stipulated in the following table and illustrations.

Minimum Clearance of Proposed Roadside Elements from the Centre of a Proposed Tree/ Single Stem Palm

Item	Proposed Roadside Elements	Refer to the Subsequent Illustration	Minimum Clearance Required from the Edge of Proposed Roadside Element to the Centre of Proposed Tree/Palm		
			Palm	Small to Medium Tree	Large tree
1	Splay corner of: - Entrance culvert - Bin centre access - Substation access - MDF room access - Fire engine access	Cl 1	1.0m	1.5m	2.5m
2	Scupper pipe/drain	Cl 2	1.0m	1.5m	2.5m
3	Lamp post	Cl 3	3.0m	3.0m	3.0m
4	OG box TAS manhole Sewer line and manhole Electrical post Fire hydrant SCV box Lighting control box Traffic control box Traffic light Lightning pits	Cl 4	2.0m	2.0m	2.5m
5	Crossings (e.g pushcart ramp for bin centre)	Cl 5	1.5m	1.5m	1.5m

Minimum Clearance of Proposed Roadside Elements from the Centre of a Proposed Tree/ Single Stem Palm

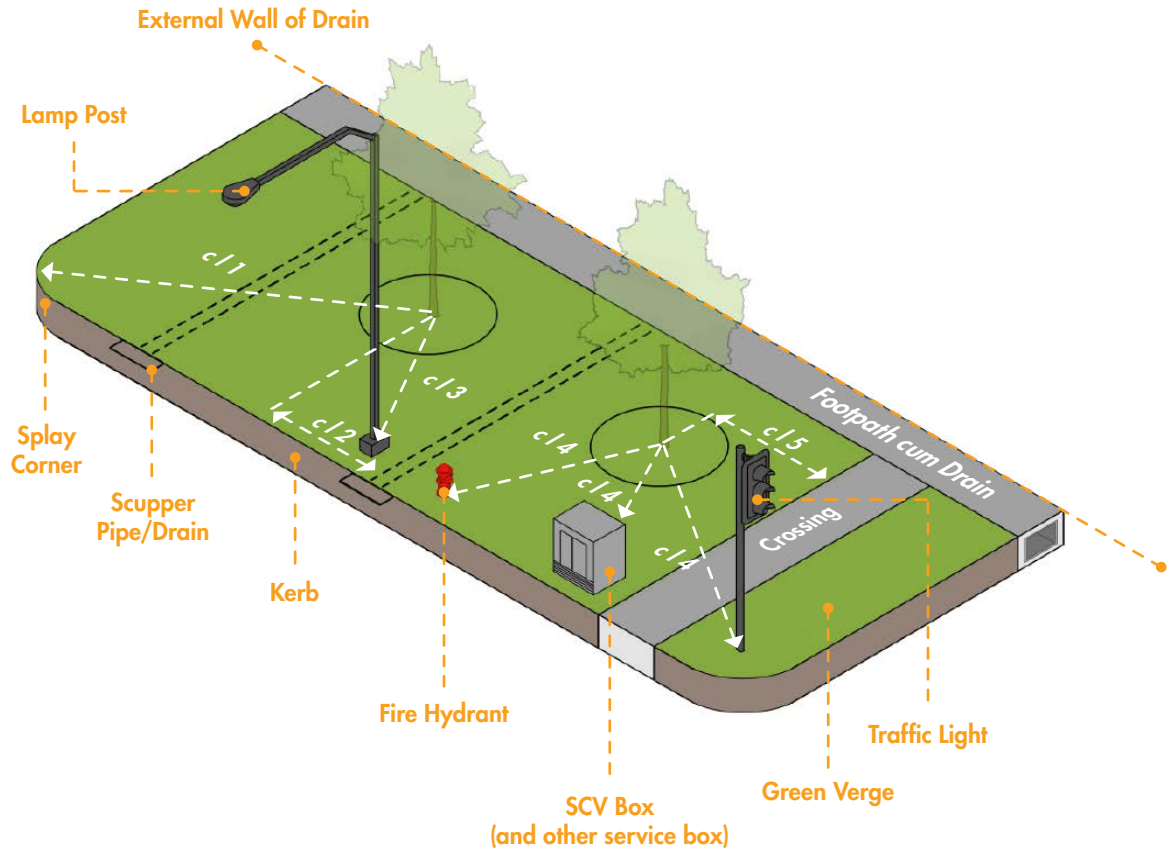

cl Clearance from the edge of proposed roadside element to the centre of proposed tree/single stem palm

Examples of Sufficient Clearance Provided from the Centre of Tree to Roadside Elements



←---→ Clearance distances should be provided as indicated in the Table above.

Example of Street Furniture, Electrical OG Boxes and Manholes grouped together to reduce the area of Green Verges being Sterilised to Facilitate Tree Planting within



Road Infrastructures

Apart from planting trees along public roads, road infrastructures such as pedestrian overhead bridges, depressed road portals, road viaducts and retaining walls should be greened up with plantings. This is to soften the harshness of the structures and to achieve pervasive greenery within the streetscape.

Pedestrian Overhead Bridge

Planting Requirements for Pedestrian Overhead Bridge

- a. Continuous planting troughs are to be provided along the span of both sides of the bridge.

Example of Continuous Shrubs Plantings within the Troughs of a Pedestrian Overhead Bridge

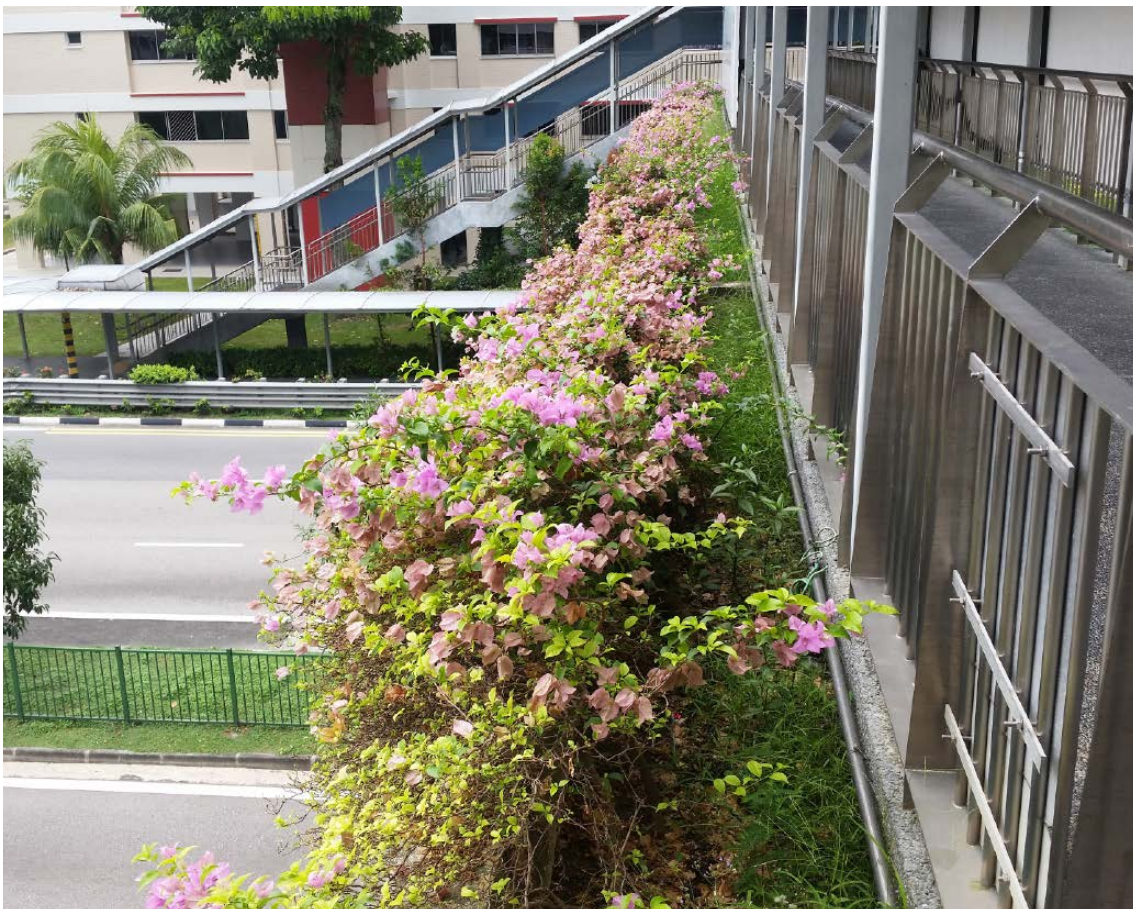

- b. The troughs should have internal minimum width of 650mm and depth of 750mm. They are to be backfilled with 3 parts loamy soil, 2 parts compost and 1 part washed sand. The proportions are by volume. Please refer to Chapter 4 on the Section under **Soil Specifications of Green Verge** for the specifications of ASM.
- c. The troughs must be waterproofed.
- d. The roof of the pedestrian overhead bridge should extend not more than 50% over the width of the planting surface of the trough laterally from the edge of the bridge deck.

Standard Design of Pedestrian Overhead Bridge with Roof Cover

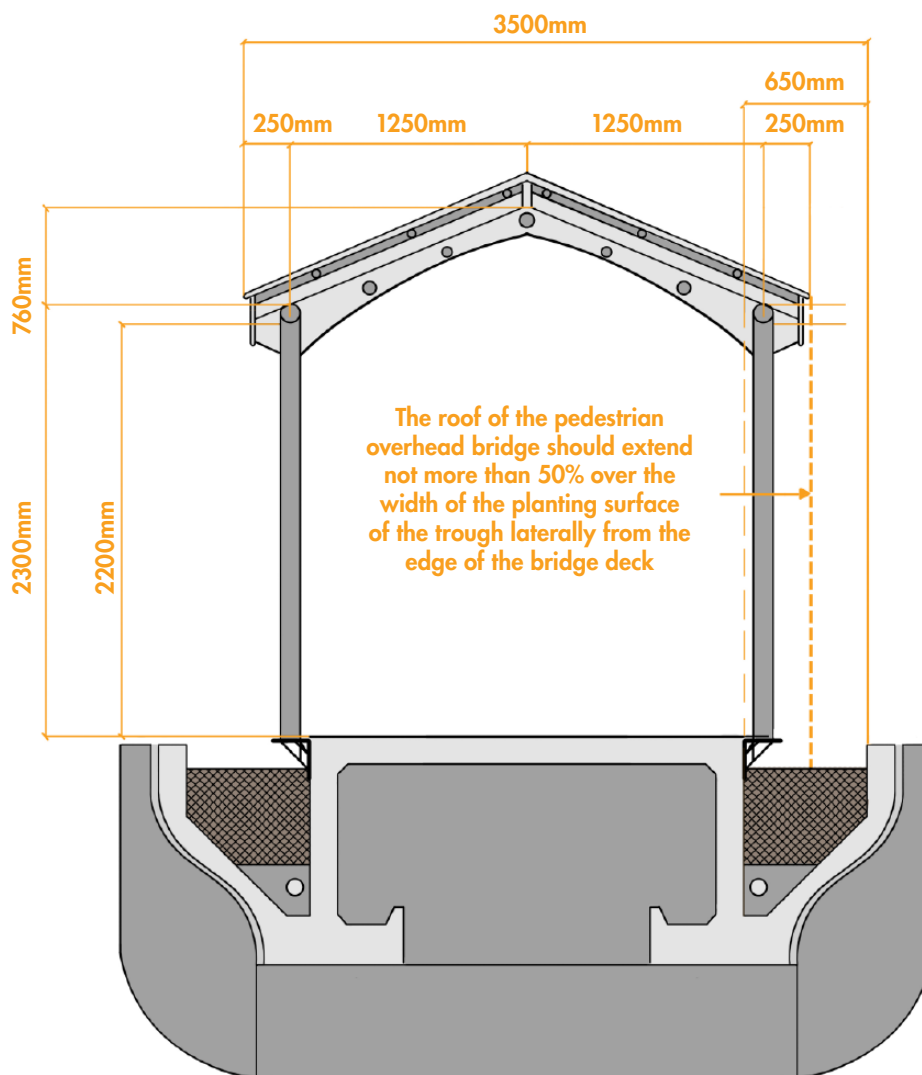

- e. Shrubs are to be planted within the troughs and the planting areas directly beneath the staircases of the pedestrian overhead bridges.
- f. All footings of the columns are to be recessed at least 0.6m below the planting level.

Irrigation System for Pedestrian Overhead Bridge

- a. For pedestrian overhead bridges less than 25.0m long, a 25mm stainless steel sprinkler pipe (with 5mm diameter holes provided at 200mm c/c along the bottom of the pipe) should be fixed to the inner wall of the trough that abuts the platform and above the soil level.
- b. For pedestrian overhead bridges between 25.0m and 50.0m long, a 25mm stainless steel sprinkler pipe (with 3mm diameter holes provided at 400mm c/c along the bottom of the pipe) should be fixed to the inner wall of the trough that abuts the platform and above the soil level.
- c. For pedestrian overhead bridges exceeding 50.0m long, a multiple pipe system with robust switch valve to channel water to different pipes is to be used. A 25mm stainless steel sprinkler pipe (with 3mm diameter holes provided at 400mm c/c along the bottom of the pipe) should be fixed to the inner wall of the trough that abuts the platform and above the soil level.
- d. The watering system pipes are to be terminated 1m above the ground level with a 37.5mm diameter male adapter.
- e. As-built drawings including catalogues of the installed materials, the frictional loss and flow rate calculations for the irrigation system are to be submitted to NParks upon hand-over.
- f. Unless there is a technical reason, e.g. long span of pedestrian overhead bridge, there should be only one coupling point provided. The coupling point should be easily and safely accessible by a water tanker.
- g. A breeching inlet which is not mounted to the column of the bridge is to be housed in a pit, flushed with ground level, with a hinged metal cover.

Typical Cross-Sectional Drawing on Watering and Drainage Systems, and Planting Troughs of a Pedestrian Overhead Bridge

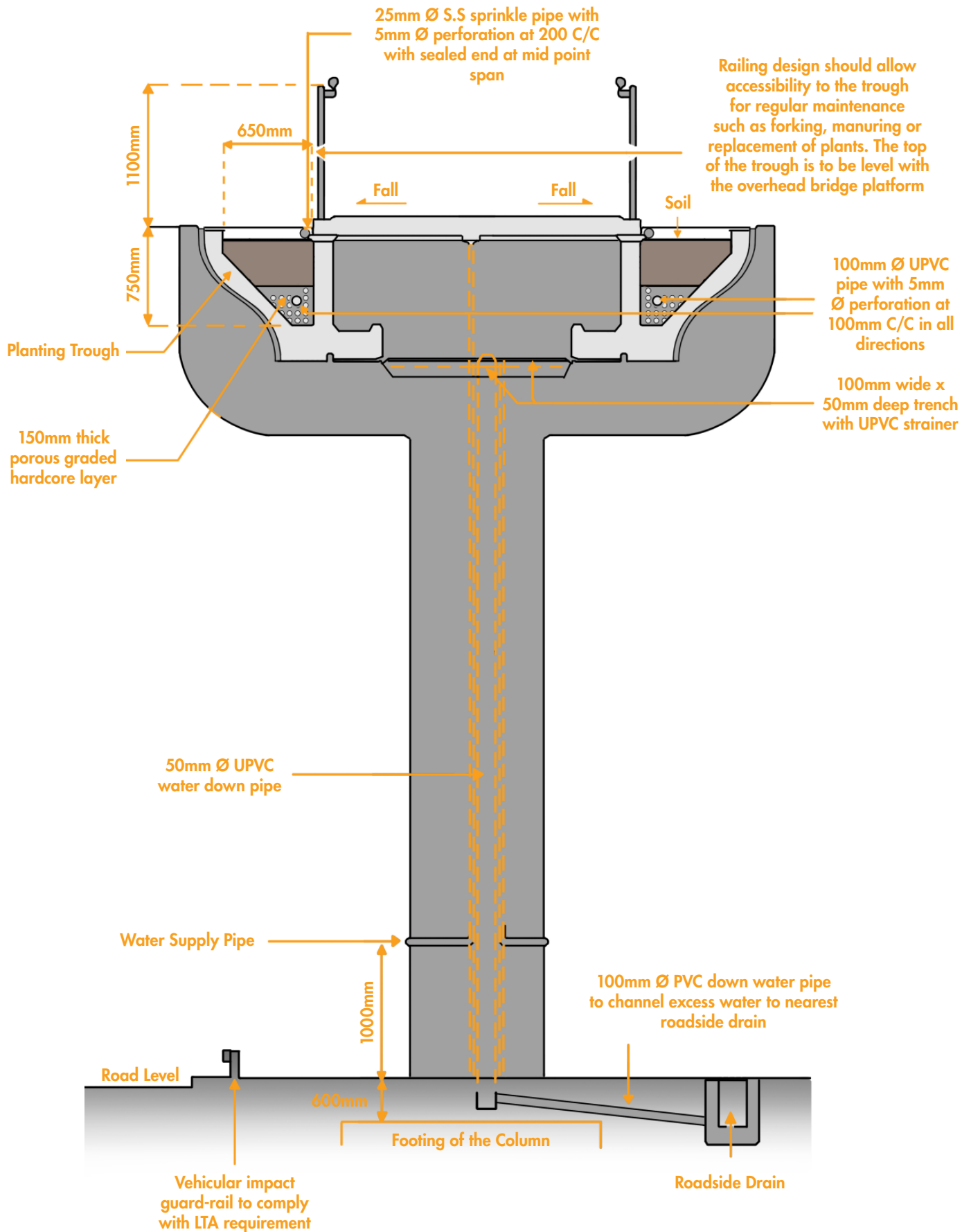

Water Tanker Lay-By

- A lay-by of 23.0m long and 3.0m width is to be provided for the water tankers, unless there is a paved shoulder. (A letter from the Land Transport Authority indicating no objection for the use of the paved area is to be attached with the submission.)
- The location of the water tanker lay-by has to be within a radius of 8.0m from the coupling point (at the column of the bridge or housed in a pit) to the mid-point of the lay-by.
- The pressure for the irrigation system must be sufficient for the irrigation to function efficiently.

Dimensions of Water Tanker Lay-By

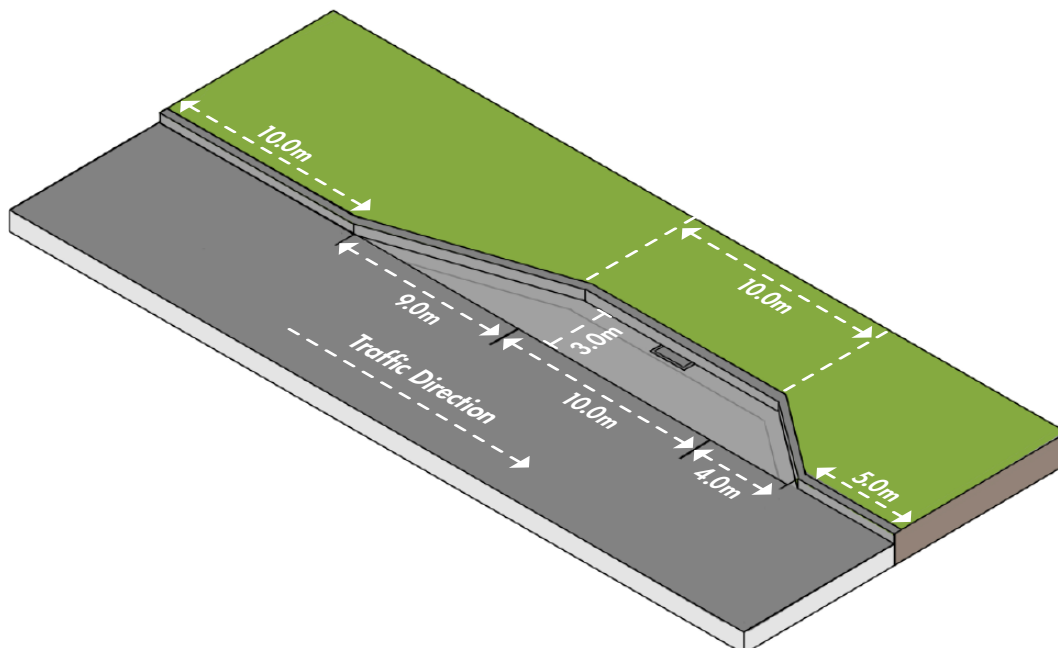

Depressed Road Portal

Planting Requirements for Depressed Road Portal

- a. A minimum 2.0m wide planting verge (exclusive of road kerb) is to be provided between the slip road and the wall of the depressed road portal for landscaping. Refer to the following illustration.

Example of an Existing Depressed Road Portal



- b. The planting verge for the depressed road portal is to be of a minimum 2.0m soil depth for landscaping.

Planting Verge between Slip Road and Depressed Road Portal

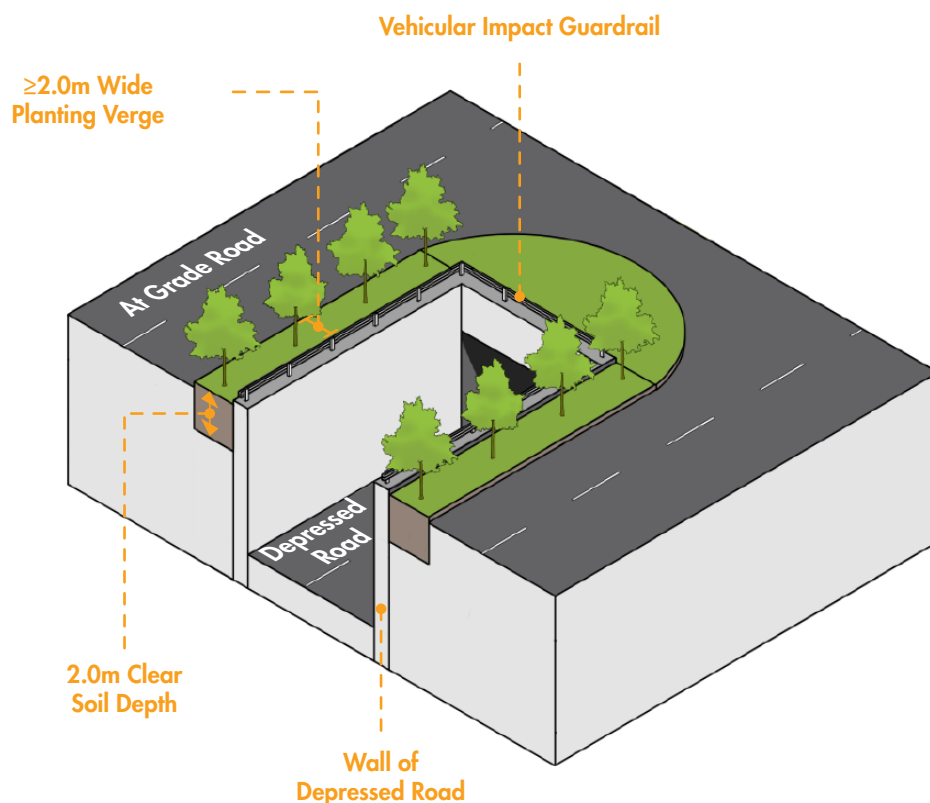

Road Viaduct/Flyover

Planting Requirements for Road Viaduct/Flyover

- a. A minimum 2.0m wide at grade tree planting verges are to be provided on both sides of the ascending/descending ramps of the road viaduct and flyover structure.

Provision of 2.0m Wide Planting Verge at the Sides of a Descending Ramp of a Road Viaduct



- b. A minimum 2.0m wide gap should be provided between two viaducts sitting parallel to one another to allow for at grade tree/shrub plantings beneath the viaducts. Refer to the following illustrations.

Example of 2.0m Wide Gap between the Road Viaducts



Example of At Grade Tree/Shrub Plantings underneath Road Viaducts



At grade plantings underneath road viaduct

- c. At the junctions where the road viaduct/flyover structures and at grade road intersect, flower troughs are to be provided at both sides of the road viaduct/flyover structures at this intersection points complying with the requirements specified on Chapter 4 on the Section under **Requirements for Flower Trough**.

Flower Trough at Side of the Road Viaduct/Flyover



Flower Trough

- d. A lay-by for the parking of water-tanker and maintenance vehicle to be provided preferably beside the slip road under the road viaduct/flyover when the flower trough is provided (refer to Chapter 4 on Section under **Water Tanker Lay-By**). Lay-by will not be required if automatic irrigation system linked to the water main is provided.
- e. Road viaduct/flyover columns are to be screened up with vertical greening (refer to Chapter 4 on the Section under **Requirements on Vertical Greening on Road Viaduct/Flyover Column**).

Requirements for Flower Trough

- a. The flower trough is to be extended at least one span beyond each intersection point of the road viaduct/flyover with the at grade road.

Plan Showing Span of Flower Troughs on the Sides of the Road Viaduct/Flyover Structure

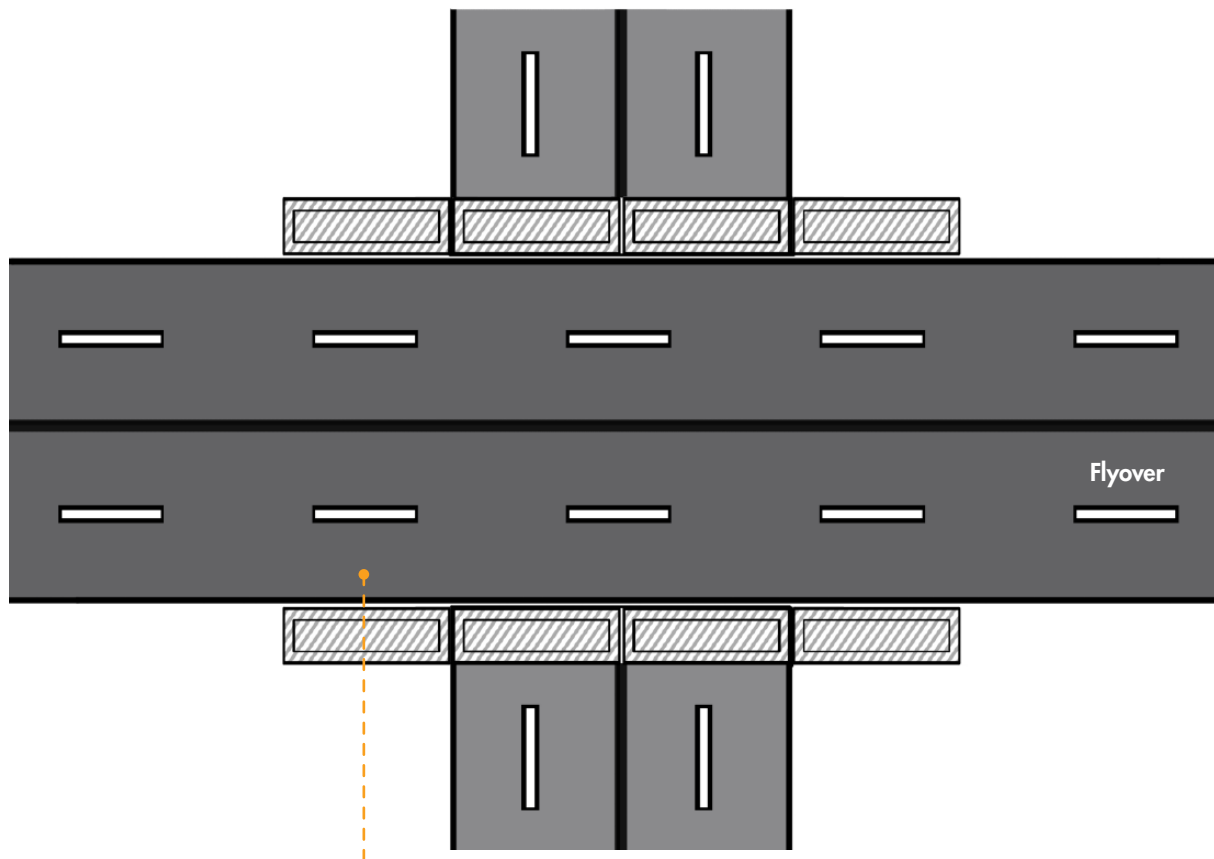

Flower trough extended by
1 span of the flyover

- b. The flower trough should have a clear width of 650mm and depth of 750mm respectively.

Dimensions of the Flower Trough

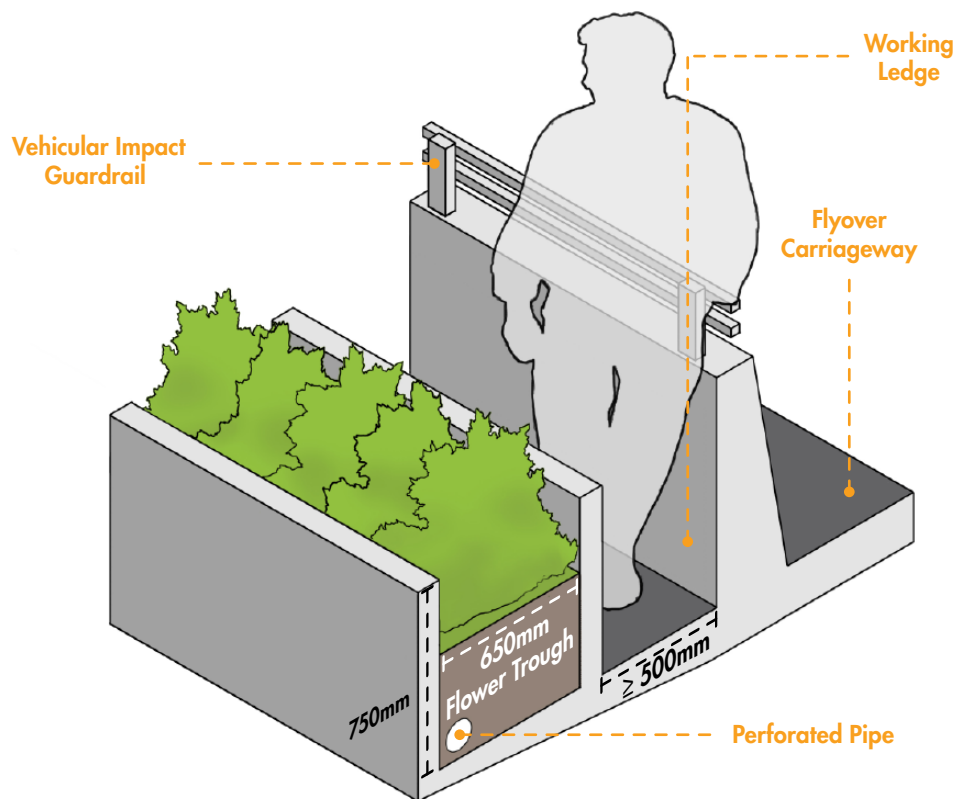

- c. A dry-pipe irrigation system is to be provided to support the irrigation of the plantings within the troughs. Irrigation pipes should be fixed to the inner wall of the flower trough and be placed above soil level.
- d. Perforated overflow pipe should be provided at the base of flower trough and designed to channel excess water to ground level by down pipes.
- e. An accessible working ledge of minimum 500mm clear width is to be provided next to the flower trough for maintenance of the plantings within. Access to the working ledge should be provided at least on both ends of the flower troughs along the road viaduct/flyover structure. This maintenance path should have a clear passage and not be obstructed by any structures (e.g. footings of the lamp post).
- f. Proposed pedestrian railing, if any installed along the flower trough, should be designed to allow workers to maintain the plants in the trough without hindrance.

Requirements on Vertical Greening on Road Viaduct/Flyover Column

- a. To provide vertical greening for the full height of the road viaduct/flyover column. We encourage developers to cater for innovative and easy-to-maintain system for the purpose of greening the columns.
- b. One possible system is the use of mesh frames, attached to the columns, to support plant growth:
 - Stainless steel mesh frames (316 grade) attached to the surface of the column structure of the road viaduct/flyover. These metal frames are to be positioned at 300mm above ground level to cover the full height of the column structure. They should be placed 300mm away from the column surface.
 - A minimum of 0.6m wide true ground planting verge is to be provided at the bottom of the column structure for the shrub plantings and for climbers to grow up vertically onto the stainless steel mesh frames to cover the column to achieve the vertical greening effect.

Example of Vertical Greening on the Columns of Road Viaduct

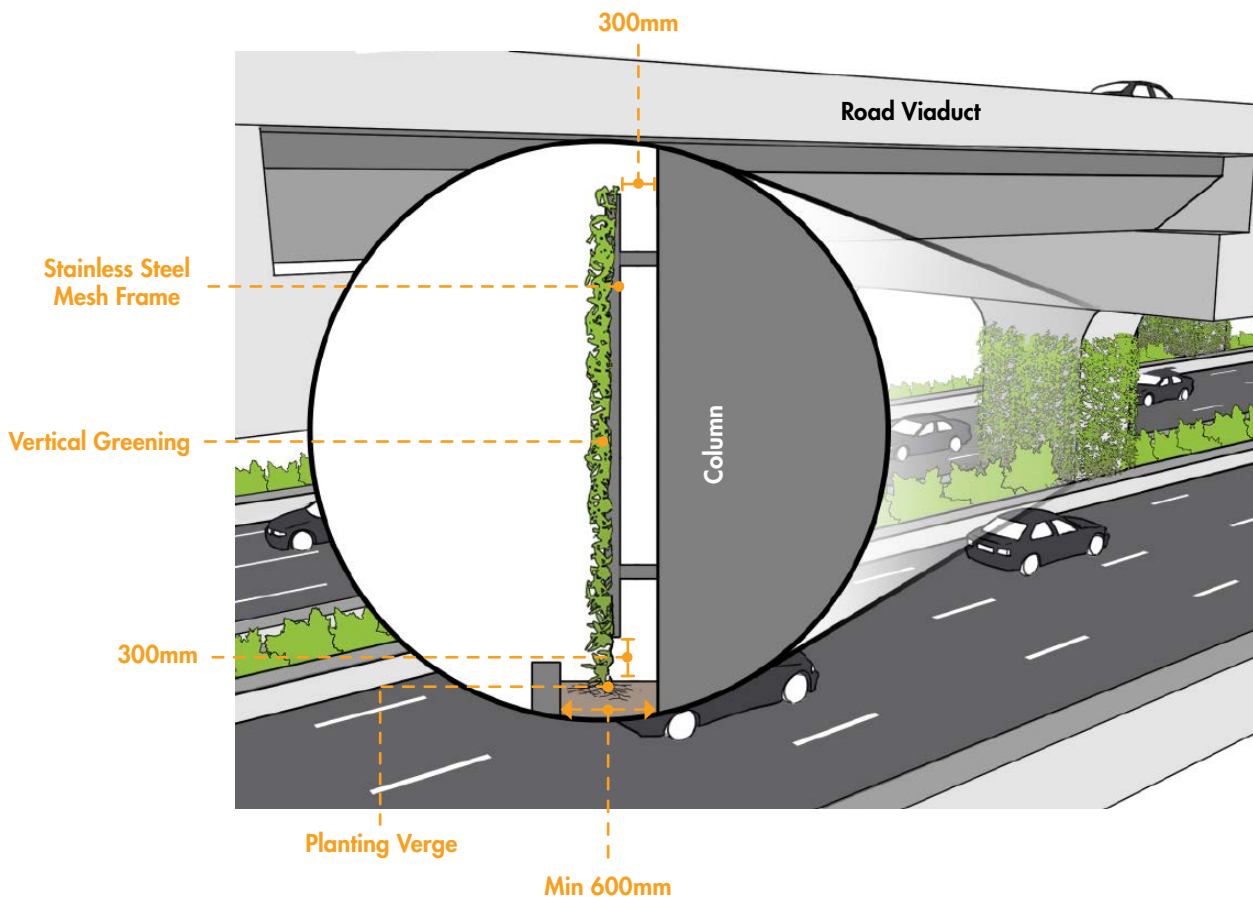

Retaining Wall

Planting Requirements for Retaining Wall

- a. All retaining walls are to be screened up with plants.
- b. Scenarios 1 to 3 (refer to the following illustrations) are the suggested options of vertical greening for the retaining wall for developers to adopt. NParks' preference is for Scenario 1, which has a row of continuous true ground planting of tall shrubs/small trees to achieve the screening effect for the retaining wall. In cases where the planting verge is limited due to site constraints, Scenario 2 and/or Scenario 3 could be considered. A combination of all the above could also be adopted.
- c. The planting verge to be provided is to be of a minimum 2.0m soil depth.

Scenario 1 Planting of continuous row of tall shrubs/small trees

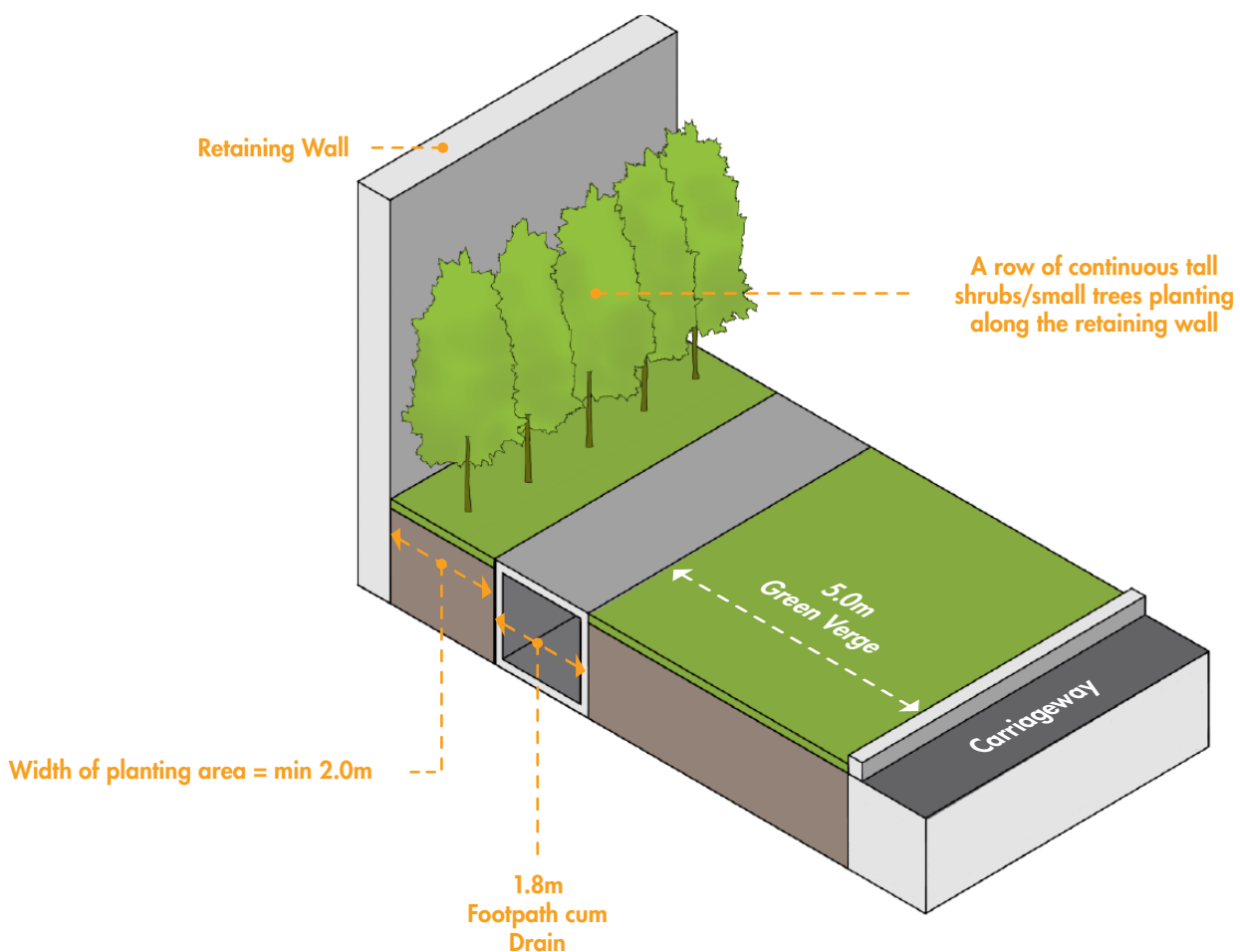

Scenario 2
Vertical metal frame with climbers (bottom up)

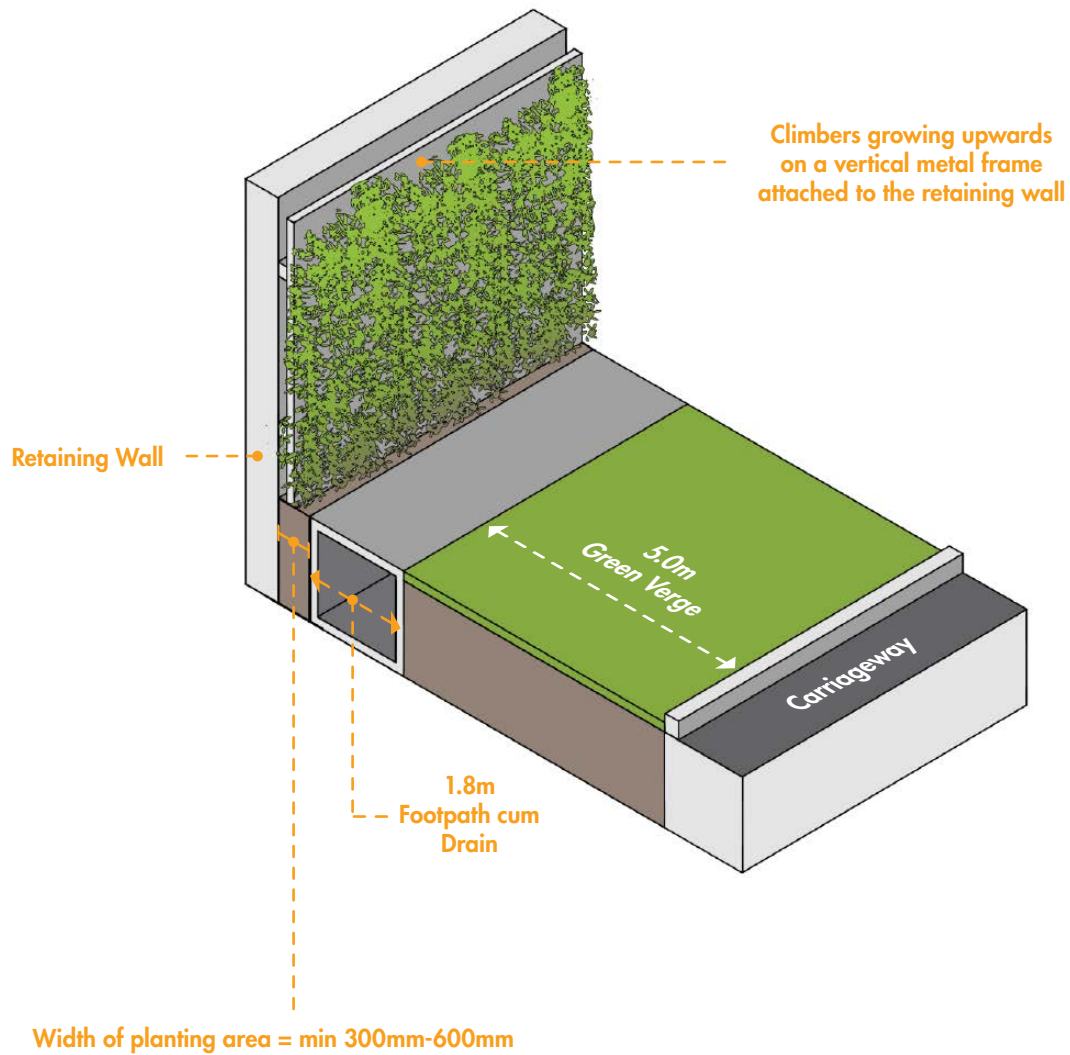

Scenario 3
Planter box with creepers (top down)

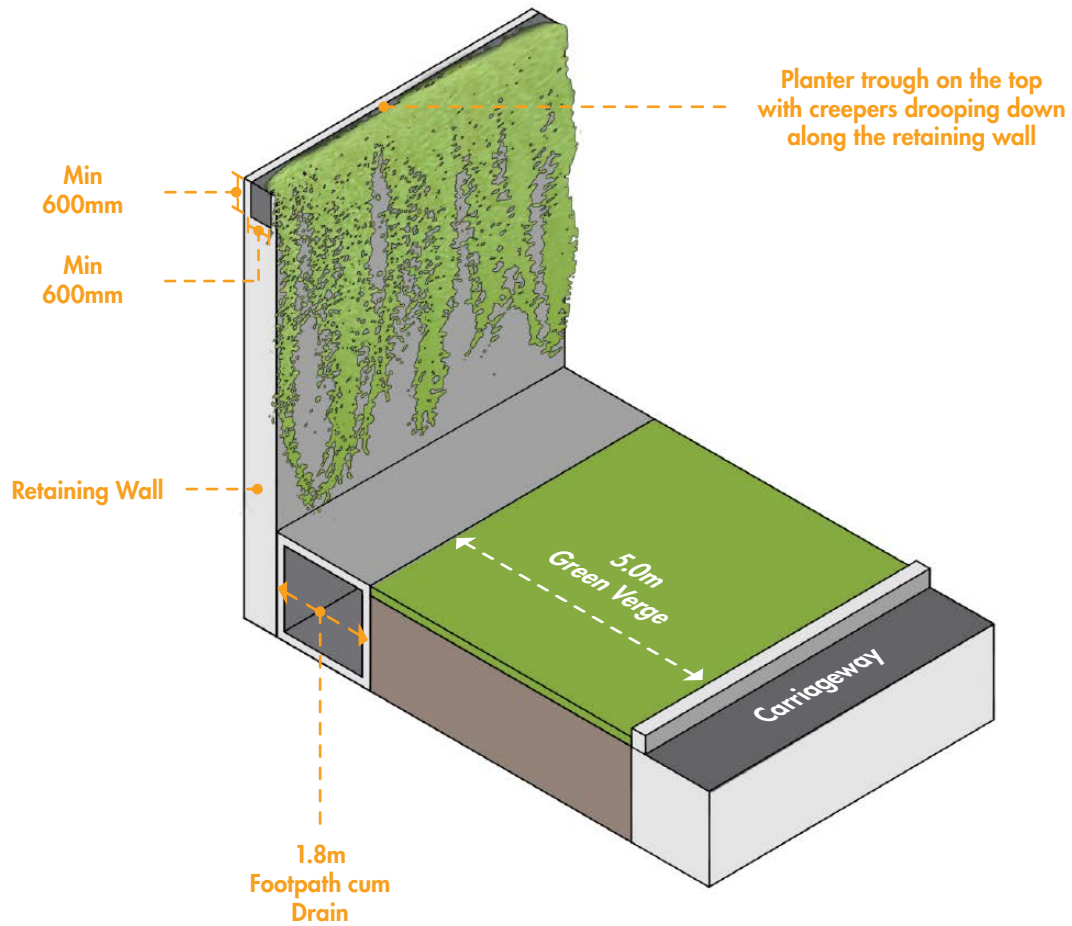



CHAPTER

- 5 Planting Specifications of Trees/Palms/
Shrubs/Hedges/Turf
- 6 Open Space for Landed Housing
Developments
- 7 Certificate of Statutory Completion (CSC)

5 PLANTING SPECIFICATIONS OF TREES/PALMS/SHRUBS/HEDGES/TURF

Trees and Palms

Newly planted trees/palms require regular watering, weeding and maintenance for at least 8 weeks for proper establishment on site.

Tree Planting

Specifications for a sapling tree:

- Have a total overall height of at least 2.5m with a clear trunk height of 1.5m (measured from ground level)
- Have a girth of at least 0.1m
- Be upright and in good form
- Have a balanced crown with full foliage
- Have terminal shoots
- No included bark at any point of branch attachment in trunk and branches
- No cutting back of central leader or at lateral branches
- Lateral branches should not overlap one another
- No pruning wound, mechanical damage and/or diseased parts
- All roots should be radially emitted from the base of the trunk (no girdling roots)

The planting hole for a sapling tree should be approximately 1.0m (L) x 1.0m (W) x 1.0m (H) and be backfilled with Approved Soil Mixture (ASM) (refer to Chapter 4 on **Specifications of ASM**).

Specifications for an instant tree:

- Have a clear trunk height of 2.0m (measured from ground level)
- Have a girth of at least 0.3m
- Be upright and in good form
- Have a balanced crown with full foliage
- Have a minimum of three primary branches of 0.5m long
- No included bark at any point of branch attachment in trunk and branches
- No cutting back of central leader or at lateral branches
- Lateral branches should not overlap one another
- No pruning wound, mechanical damage and/or diseased parts
- All roots should be radially emitted from the base of the trunk (no girdling roots)

The planting hole for an instant tree should be approximately 1.5m (L) x 1.5m (W) x 1.0m (H) and be backfilled with ASM.

Palm Planting

Specification for a single stem palm:

- Have a total overall height of 2.0m (measured from ground level)
- Be upright and in good form
- The head of the palm should be well balanced with at least five (5) leaves and one (1) growing terminal shoot
- No pruning wound, mechanical damage and/or diseased parts

The planting hole for single stem plant should be approximately 1.0m (L) x 1.0m (W) x 1.0m (H) and be backfilled with ASM.

Staking

Staking serves to support the tree, and must be maintained until the tree is established or otherwise instructed by NParks. During the establishment period and before the handover to NParks, all missing, fallen and damaged staking should be replaced.

All sapling tree/instant tree/single stem palm are to be staked unless otherwise instructed by NParks. Methods of staking are as follows:

Double Staking — Sapling Tree and Palm

- Two galvanised steel pipes of 25mm diameter shall be used per sapling tree/palm.
- Stakes should be of height slightly lower than the sapling tree/palm and one-third buried underground.
- Stakes should be positioned 200mm away from the collar of the tree.
- PVC tubed nylon strings should be used to fasten the stakes to the tree.

Galvanised Pipes Staking (Double Staking)

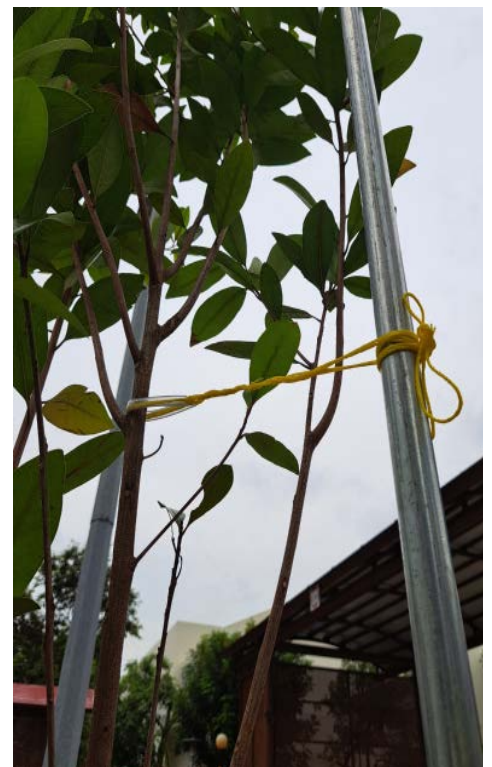
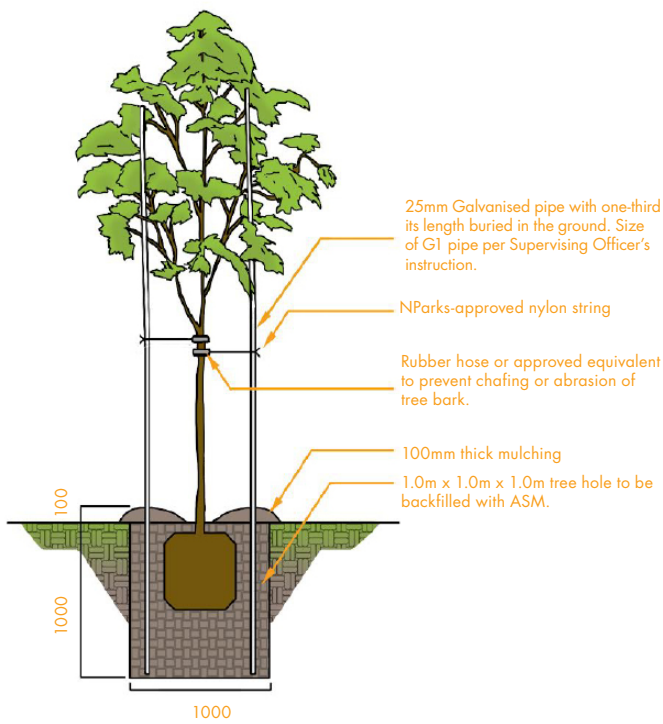

Tripod Staking — Instant Tree

- Three galvanised steel pipes of 25mm diameter shall be used per instant tree/palm.
- Stakes should be of height slightly lower than the instant tree/palm and one-third buried underground.
- Three or four stakes shall be positioned equidistantly around the tree and firmly driven into the ground at an angle of 30-40 degrees.
- The stakes shall extend beyond the tree trunk by not more than 0.15m and shall not be higher than 0.3m below the lowest branch.
- The tree trunk shall be wrapped in gunny sack at the point where the stakes are to be fastened in order to prevent bark damage.
- PVC tubed nylon strings should be used to fasten the stakes to the tree.

Galvanised Pipes Staking (Tripod Staking)



Tree Collar Protector

Tree collar protectors are to be provided for all proposed sapling trees/instant trees/single stem palms. A protector is to be made of a PVC tube with a length of 200mm, 75mm diameter and 2mm thickness with a slit cut along the full length of the tube.

Mulching

Mulching should be provided for all proposed sapling trees/instant trees/single stem palms.

- Initial mulching is to take place within two days of planting.
- All weeds at the tree bases are to be removed before spreading the mulch.
- Mulch should be forked slightly into the soil and should not be heaped up into a high mound more than 100mm thick. Mulch materials should not come into contact with the root collar of the tree or palm.
- Mulching should be organic in nature, e.g. compost. Mulches shall be an approved friable and composted organic material such as wood chips, oil palm husks, oil palm kernels, organic compost or an approved mix. Coco-peat will not be allowed on its own unless mixed in a proportion of 50-50 with another mulching material free from soluble salts or toxic materials and resistant to rapid decay. Mulches shall have a pH of 5.5-7.0.

Good Mulching Practice



Shrubs and Hedges Plantings

- Shrubs should have a height of 0.3m to 0.5m and planted at 0.3m to 0.5m centre to centre.
- For purpose of hedge planting, shrubs should have a minimal height of 1.0m and planted at 0.5m centre to centre.
- Free from pest and disease.

Turfing

- Only healthy and vigorous stock of *Axonopus compressus* shall be used for turfing and reinstatement.
- All turf should be free from weeds, especially *Mimosa pudica*, *Imperata cylindrica* (lallang) and *Eleusine indica*.
- In transporting the turf to site, the turf shall be cut square approximately 0.3m (L) x 0.3m (W), and 0.05m in thickness.
- Pieces of turf shall be laid abutting (close turfing) each other with no appreciable spaces between adjoining pieces. On completion, the turfing should present a uniform and regular appearance.
- Turf should be planted on approved soil mix, minimally 0.1m deep.

Vigorous and Healthy *Axonopus compressus* with Deep Green Colouration



Urban Greenery Series RTN 05-2016 July. Author: Chin Siew Wai

6 OPEN SPACE FOR LANDED HOUSING DEVELOPMENTS

Introduction

Landed housing developments, or any other developments as stipulated by URA, are required to provide open spaces to be used as public parks. Such open spaces will be vested to the Government. The developers will be required to enhance the open spaces with features, such as exercise equipment and playground, before handing over to NParks for subsequent management.

Provision for Open Space

The formula for computing a proposed open space is 4.05m² to every 56.0m² of gross floor area (GFA) [area of open space = (GFA/56.0m²) x 4.05m²]. This is subject to the following:

- A minimum plot area with an open space of 1,000m²
- A regular shape with a width of at least 30.0m
- Not be fragmented by a road, canal or other infrastructures
- Be free from encumbrances above and below the ground level

Vesting of Open Space

The open space plot is to be vested back to the State upon completion of the Landed Housing Development. QP is required to submit URA's Written Permission on the vesting of open space and the updated survey plan showing the new demarcation and lot number(s) to NParks. (refer to Chapter 8, **Submission Procedure**)

Location of the Open Space

- The open space should be suitably located within the proposed development and be conveniently accessible to the community.
- It should be located such that at least two sides face the front of a house(s), and none faces the rear of a house(s).
- The walking distance measured along the pedestrian walkway from the furthest house unit to the proposed open space should not be more than 250m.
- It should not abut a major road.
- It should not abut existing/proposed retaining wall.
- If the proposed development is adjacent to a proposed or existing Park Connector, the open space is to abut the Park Connector provided that:
 - a. The Park Connector does not abut a major road.
 - b. The maximum walking distance from open space to house unit (as stated above) can be achieved.

Accessibility of Open Space

- At least one of the boundaries of the open space is to abut an existing minor road or a new local access road.
- The proposed entrance or access path to the open space should be at least 4.0m wide. Retractable bollards must be at least 900mm apart with locks installed in order to curb illegal entry/parking. The spacing of bollards should allow for wheelchair accessibility.
- The accessibility of open space in general should be designed in accordance with the Building Control Authority's (BCA's) Code on Accessibility in the Built Environment (Design Guidelines for Parks and Open Spaces)*.

*Refer to BCA's website for the latest BCA's Code on Accessibility in the Built Environment.

Terrain of Open Space

- The open space should generally be flat with a ratio of 1:40. If the site situation does not permit, the proposed slope should not be steeper than 1:2.5. For a steep slope, appropriate measures to ensure slope stability and protection must be proposed and endorsed by a Geotechnical QP. Plans, illustrating the endorsed measures, must be submitted to NParks for our approval.
- The level of open space should be the same or higher (subject to NParks' approval) than that of adjacent road(s) and neighbouring lots.

Provision for Drainage

- Suitable and sufficient drainage for the open space should be provided. This includes sump pits to channel away surface water so as to prevent flooding on hard surfaces as well as lawn areas.
- The open space should be properly graded to prevent water ponding and to efficiently channel storm water run-off to the proposed drains for discharge at the main outlet channel.
- The types of drains to be provided where necessary are:
 - a. Open drains with hinged grating covers (materials are subjected to NParks' approval) or scupper drains to be provided along footpath. For a footpath designed for maintenance vehicle, vehicular grating should be provided if there is a drain abutting to the footpath. Drain gratings should meet barrier free requirements.
 - b. Subsoil drains under open lawns.
 - c. Subsoil drains under playground and fitness areas.

Playground/Fitness Equipment and Space

Provision of Space

- An area of at least 100m² shall be provided for the proposed playground equipment within the open space. This may be substituted with fitness equipment in situations where there is existing or proposed playground equipment in another open space within the vicinity.
- There should be at least one barrier-free access route from the main circulation path system to the playground and fitness areas. The dimensions of the barrier free access route shall be in accordance with BCA's Code on Accessibility in the Built Environment (Design Guidelines for Parks and Open Spaces)*.

*Refer to BCA's website for the latest BCA's Code on Accessibility in the Built Environment.

General Specifications

- The playground and fitness equipment should be housed in separate areas.
- Adequate seating should be provided around the playground and fitness area.
- The playground/fitness equipment shall be barrier-free and accessible by the physically challenged in accordance with Singapore Standards — SS 457: 2007 Specification for Playground Equipment for Public Use* and SS 534: 2007 Specification for Outdoor Fitness Equipment for Public Use* respectively.
- All playground and/or fitness equipment is to be situated within acceptable protective surfacing materials complying with Singapore Standards — SS 495: 2001 — Impact Attenuation of Surface System under and around Playground Equipment*. The protective surfacing shall be designed to ensure the shock absorbency of the surfacing material is based on the highest accessible part of equipment. The surfacing material must yield both a peak deceleration of no more than 150 G-Max and a Head Injury Criteria (HIC) of no more than 750.
- All playground and fitness equipment must be earthed with Lightning Protection System (LPS). This LPS shall be designed and endorsed by QP (M&E).

* Refer to latest version of standards online.

Requirements for Playground Equipment

- The playground area should be designed with playground equipment catering for children ranging from 2-5 years of age and 5-12 years of age. The playground equipment could comprise composite sets and stand-alones, providing a minimum of eight different playground activities. Each composite set of playground equipment shall have at least five different playground components.
- The playground equipment should be physically and mentally stimulating.
- There should be a clear defined edging between the playground area and adjacent surfaces. The playground area, adjacent ground and edging should be flushed with each other.
- The design of the playground space should be sensitively designed to allow the physically challenged to participate with other users, without any spatial discrimination. All designs shall be checked and endorsed by a Certified Playground Safety Inspector (CPSI).
- Subsoil drainage should be provided within sand pit or playground areas. These subsoil pipes should be linked to the nearest drain.
- The playground equipment shall be designed and constructed or assembled in accordance with Singapore Standards — SS 457: 2007 Specification for Playground Equipment for Public Use*.

* Refer to the latest version of standards online.

Requirements for Fitness Equipment

- For the fitness area, a set with a minimum of six stations with relevant instruction signboards shall be provided.
- At least 50% of the fitness equipment proposed should be suitable for use by the elderly.
- Fitness area should be sufficiently shaded with instant trees. Please refer to the specifications of instant trees in Chapter 5, **Planting Specifications of Trees/Palms/Shrubs/Hedges/Turf**.
- The fitness equipment shall be designed and constructed or assembled in accordance with Singapore Standards — SS 534: 2007 Specification for Outdoor Fitness Equipment for Public Use*.

* Refer to the latest version of standards online.

Certification and Warranty

- The footings and support structural elements for playground and fitness equipment must be designed with structural safety endorsed by a QP (Structural Engineer).
- The completed playground and fitness area will have to be checked by third party CPSI and certified safe prior to opening for public use.
- The supplier for the imported playground and fitness equipment and Ethylene propylene diene terpolymer (EPDM) has to provide a five-year warranty transferable to NParks. The validity of the product warranty shall not be less than four years at the time that the product warranty is transferred to NParks.

Footpath

- The design of a footpath shall be in accordance with BCA's Code on Accessibility in the Built Environment 2013 (Design Guidelines for Parks and Open Spaces)*.
- Any footpaths leading to or away from the open space should be flushed with the open space upon intersecting.
- The material of the footpath and any other pavement should ensure the physically challenged are able to move with ease and is non-slip during dry and wet weather.
- For a wider footpath (min 3.0m) used for vehicular access, it must be designed with the appropriate loading for such use. Engineering details are to be submitted for NParks' approval.

*Refer to BCA's website for the latest BCA's Code on Accessibility in the Built Environment.

Park Furniture

- The supplier is required to provide a quality warranty of all park furniture, which is transferable to NParks.
- The materials used should be durable and vandal proof.
- The use of timber should be minimal. No timber is to be used for railings and litterbins.
- All timber should be obtained from well-managed, guaranteed sustainable wood sources.

Signboards

- The name of the open space should be submitted to NParks as soon as the name is approved by URA's Street & Building Names Board (SBNB). The purpose of the application to NParks is to ensure that only one name can be allowed for a development and it will not duplicate a name that is already in existence so that there is clarity in the identification of the open space. The application form for naming of open space is available on NParks' website.
- Signboard(s) should be installed at/near the entrance of an open space. When there are multiple entrances located far apart, more than one signboard may be required.

Specifications and Installation of Standard Signboard

- The design and construction of the footings shall comply with the current BCA.
- All sharp corners are to be rounded off.
- All noticeboards must include soft boards. Size and thickness of the soft board are subjected to NParks' approval.
- Electrical works must be carried out by a licensed electrical worker. Lighting and necessary cabling will be terminated at a splash-proof junction box, which is 300mm above ground surface. Junction boxes are to have a 6A DP MCB for the incoming cable.
- All cabling and wiring are to be concealed within the structure.
- A 128mm diameter NParks logo should be printed on the front of the signboard with a 3M engineering grade outdoor reflective vinyl sticker with a three-year warranty. For details on the graphic, refer to the subsequent NParks Logo illustration. The logo should only be printed at the time of the hand over of the open space to NParks.
- The size of the lettering for the name of the open space should not be less than 150mm in height.
- The colour visuals and finished artwork of graphics (FA) and text are to be submitted for approval. The softcopy of the FA is to be handed over to NParks upon completion of the project.

NParks Logo

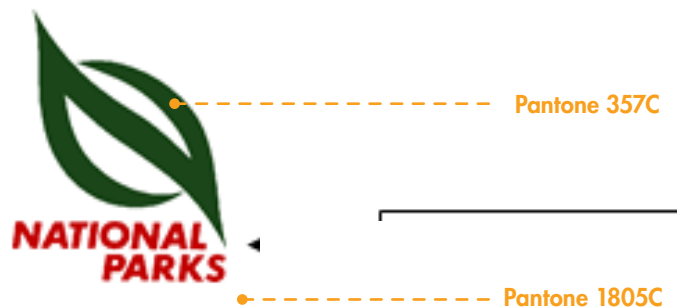

Please refer to the following illustrations for the specifications for the standard signboard.

Standard Entrance Signboard/Noticeboard (Type 1)

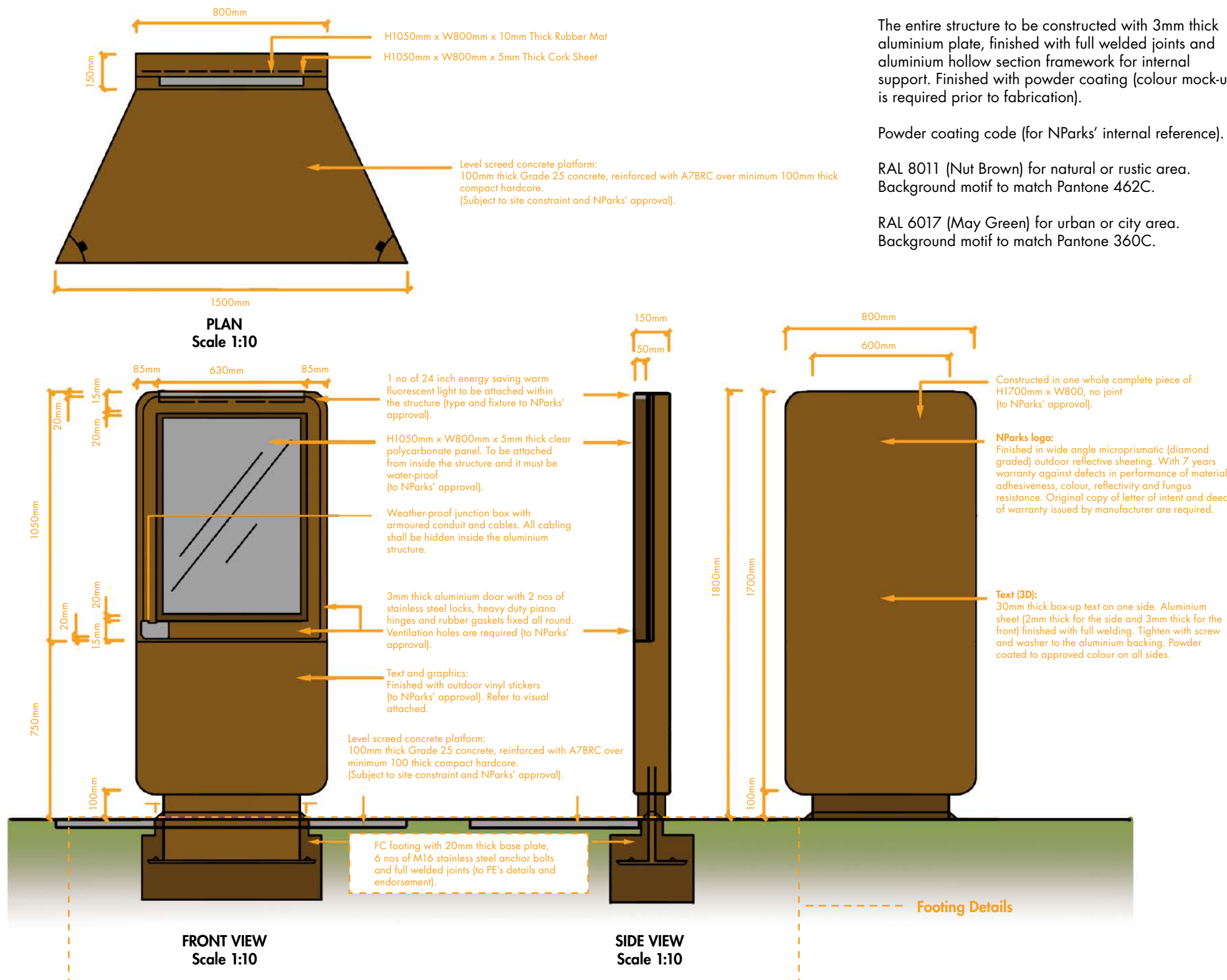

NOTE:

The entire structure to be constructed with 3mm thick aluminium plate, finished with full welded joints and aluminium hollow section framework for internal support. Finished with powder coating (colour mock-up is required prior to fabrication).

Powder coating code (for NParks' internal reference).

RAL 8011 (Nut Brown) for natural or rustic area. Background motif to match Pantone 462C.

RAL 6017 (May Green) for urban or city area. Background motif to match Pantone 360C.

GENERAL NOTE:

Contractor is to fabricate, deliver and install the structure shown in this drawing.

Contractor is to engage a qualified Professional Engineer (PE) for the complete design and endorsement of all structures including of footing, foundation and the 3D signage structure above ground level.

This drawing indicates the design intention. Contractor is to submit shopdrawing to illustrate how the design intention can be achieved, for our approval.

Contractor is to submit visuals and FA for approval. Editable master copy of FA to be burnt into CD and handed over to NParks upon completion of project.

Electrical works must be carried out by licensed electrical worker. Lighting and any necessary cabling will be terminated at splash proof junction box which is 300mm above ground surface. Junction box is to have ELCB 0.3MA switch. Cost of cabling and all necessary works to be included in this contract.

All cabling & wiring to be hidden or concealed within the structure.

All sharp corners to be rounded off.

Standard Entrance Signboard/Noticeboard (Type 1) for Visual Purposes (Nut Brown)

Note:
For visual purposes only.
Nut Brown for natural or rustic area.



Standard Entrance Signboard/Noticeboard (Type 1) for Visual Purposes (May Green)

Note:
For visual purposes only.
May Green for urban or city area.



Standard Entrance Signboard with Noticeboard or Mapboard (Type 2)
 (All measurements are in mm)

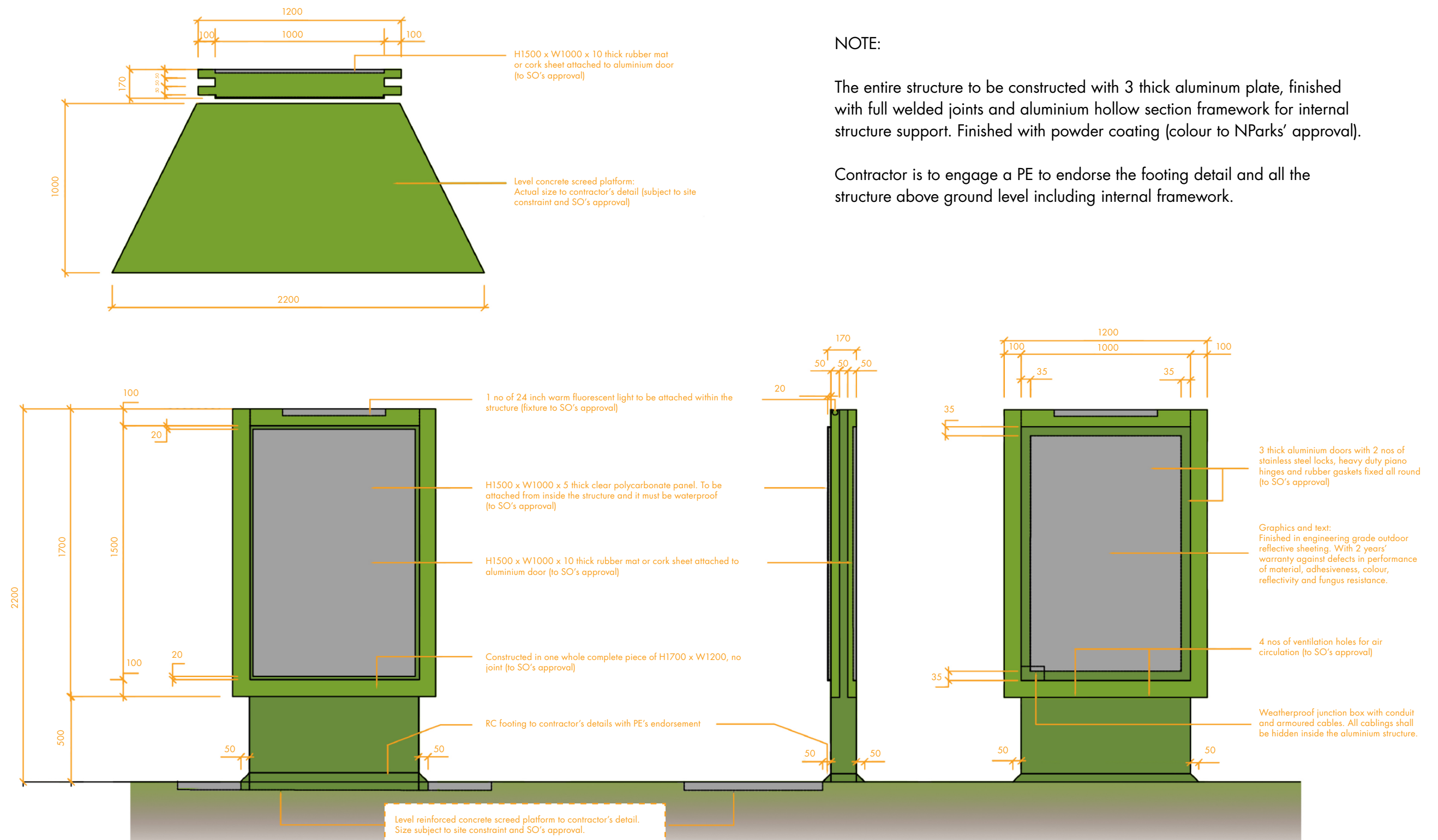

NOTE:

The entire structure to be constructed with 3 thick aluminum plate, finished with full welded joints and aluminium hollow section framework for internal structure support. Finished with powder coating (colour to NParks' approval).

Contractor is to engage a PE to endorse the footing detail and all the structure above ground level including internal framework.

Parks Entrance Signboard



Rear of Parks Entrance Signboard/Noticeboard/Mapboard



Signage

NParks will require signage to be erected at various locations within the open space. Some examples of signage are illustrated in the subsequent sections.

Prohibitory Signs

Park Activities



Parking and Vehicle-Related



Advisory Signs

Park Activities



Other Notices



Hybrid Signs

Park Activities



Animal



Note:
Hybrid signs are subjected to NParks' approval.

Benches

- A concrete platform should connect the benches to footpaths.
- The finished platform should have a level that matches with the footpath.

Litter Bins

- Litter bins should be placed on a raised concrete base.
- They should be located 3.0m to 5.0m away from a bench.

Note:
QP is to check with National Environment Agency (NEA), Department of Public Cleanliness for the specifications of litter bin.

Shelter

- A shelter of not less than 20.0m² in area should be provided.
- Submission to relevant authority has to be sought and approved prior construction. Approval letter and TOP has to be obtained and submitted at post construction.
- The proposed plan has to be endorsed by a QP (Structural Engineer) that the structural safety of the proposed shelter complies with the current BCA.
- The shelter shall be provided with lightning protection system in accordance with Singapore Standards – SS 555:2010 Code of Practice for Lightning Protection*.
- The QP of the development is advised to consult NParks on the aesthetic design and materials to be used for the proposed shelter.
- The minimum height of the roof overhang should not be less than 2.4m measured from the finished floor level to the underside of the roof members. The proposed roof overhang should not be less than 900mm measured from the side of the column or wall.
- Shelter should be open sided to promote natural ventilation.
- A perimeter drain with a sump pit is to be provided to discharge surface water from the shelter.
- A multiple gang switch 13A weatherproof type socket outlet, with plug top and metal screwed cover in GI conduit up to 3 x 15.0m run of 1.5mm sq PVC cables, is to be provided and installed in the shelter.

* Refer to latest version of standards online.

Safety Railings

When the edge of an open space and/or path borders a slope that is steeper than the ratio of 1:2.5, safety railings complying with the following are to be provided:

- To be designed in accordance to BCA requirements.
- Durable materials used, such as stainless steel material grade 316 with hairline finishes for marine environment or hot dipped galvanised material with five years warranty period. Alternatively, proposed aluminium material with 6000 series and above will be acceptable.
- The colour should match the colour scheme of the open space.
- For open drains of more than 1.0m deep, safety railings shall be installed within the drainage reserve. This is to comply with the technical requirements of Public Utilities Board (PUB) Catchment and Waterways Department.

Park Lighting and Over Ground (OG) Box

This section of the guideline shall be used in tandem with NParks' latest "Mechanical & Electrical services checklist". (refer to NParks' website for the checklist.)

Lux Level Provisions

- The architect and lighting consultant should do a site measurement of the existing lighting level as a basis for the lighting proposal for the open space.
- Higher luminance should be proposed for park amenities such as car parks, shelter, etc.
- An estimated electrical bill is to be provided.

Lux Level Provisions

Lux Level	Sub-Urban Areas (Open Spaces within the Housing Estate, In General)	Urban Areas (Open Spaces Located in the Main Thoroughfare, e.g. Pavement to MRT Station, Buildings or near Bus Stop)
Proposed average lighting level along footpath	5 Lux	10-20 Lux
Playground and fitness area	20 Lux	N/A

Lantern Design

- Diamond and cone shaped designs with diffusers are recommended if wider light coverage is needed. Photograph samples have to be submitted for NParks' reviews.
- The proposed lantern should be:
 - a. Vandal resistant
 - b. Ultraviolet stabilised for the plastic components
 - c. Easily available locally
 - d. PSB batch tested to comply IP65

Bulb Type

Integrated Compact Fluorescent (CFL) bulbs, Light Emitting Diode (LED) or other energy saving bulbs are recommended. The type and technical specifications are as follows:

- 60W CFL bulb, or equivalent
- 220-240V (50/60 Hz)
- Lighting output of 3400 lumens or higher
- Colour temperature of white 2700K or 6400K

Lamp Pole

The following are the recommended technical requirements.

- The pole should be installed at least 3.5m to 4.0m away from any park seating, trees and hedges. Installation on sand, waterlogged and/or soft ground should be avoided.
- The pole height should be between 3.0m to 3.5m measured from ground level.
- The pole should be 0.5m away from the edge of the footpath.
- Labelling should be 1.5m above ground level with the wording size of 0.006m x 0.0019m x 0.0034m (red 3-M sticker). The numbering should be continuous from the first (no 1) to the last pole.
- The material thickness of the pole should be at least 0.0025m and material should be power coated with a 10-year warranty period.
- Flange-mounted type should be mounted on exposed concrete foundation 0.05m above ground level to strengthen and maintain the position of the pole.
- L-angle bracket for mounting the baseboard and cable gland is to be provided at the internal surface of each pole.
- The accessible door to the cable cut out unit with High Rupturing Capacity (HRC) fuse should be lockable with an Allen key. The door should be flushed with the pole and should be 0.5m from the ground level.
- The cable entrance is to be sealed.
- The pole door plate should be secured to the pole using a stainless steel chain.
- All bolts and nuts to be stainless steel grade 316.
- An earthing terminal and earth rod complete with a concrete inspection pit must be provided on the last pole of each circuit. The earth pit cover should be removable and made from heavy-duty hot dipped galvanised iron.

Soft Landscape and Tree Planting

- All planting area within the open space is to be planted with 50mm thick *Axonopus compressus* (cow grass) in close turfing (refer to Chapter 5, **Planting Specifications of Trees/Palms/Shrubs/Hedges/Turf**).
- Instant shade trees are to be planted around the playground, fitness corner and sitting areas to provide shade. The trees should have clear trunk heights of 3.0m or more; live crown ratios of 60:40 and primary, secondary and tertiary branching.
- Tree selection should be based on the following guidelines:
 - a. Indigenous tree species are preferred.
 - b. Trees with spreading canopy for shade provisions.
- Shrubs can be proposed at focal points such as entrances or high activity areas. For structures such as retaining wall, fence or drains, abutting the playground, planting of hedges can be used to soften the hard structures or for screening purpose.
- Mulching is required for all trees and planting beds.

7 CERTIFICATE OF STATUTORY COMPLETION (CSC)

Introduction

CSC is a statutory requirement administered by the Commissioner of Building Control. QP is required to apply to BCA for CSC when a building work registered under him/her is completed. Prior to the CSC application to BCA, the QP must obtain all these approvals from relevant technical agencies/departments including NParks.

NParks CSC Approval

NParks CSC approval could be categorised into internal and external works. NParks' BP approval will indicate whether CSC approval is required. If both internal and external CSC are required, only one consolidated CSC approval will be issued when both the works have met NParks' requirements and are in accordance with the approved plans.

CSC for Internal Work

This is for works within the development premises. An NParks officer will check the following (where applicable):

- Conservation of mature trees within TCA/vacant land.
- Provision and landscaping of green buffers, peripheral planting verges and planting areas at open air parking area at street level.
- Provision and implementation of open space for landed housing developments.

It is the owner's responsibility to maintain plantings and planting verges within the premises.

CSC for External Work

This is for works outside of the development premises, usually along the roadside. An NParks officer will check the following (where applicable):

- Conservation of roadside trees.
- Provision, reinstatement and landscaping of roadside green verges.
- Provision and landscaping of the planting trough, as-built irrigation system plan for POB.
- Provision and implementation of PCN.
- Reinstatement of areas under the management of NParks.

NParks will undertake the maintenance of proposed roadside trees and grass cutting when CSC approval is granted.

CSC Inspection

As part of the CSC application process, an NParks officer will arrange for a joint site inspection, together with the QP and other relevant stakeholders. The inspection is to verify that the completed works are in accordance with the approved plans and meet NParks' requirements.

CSC inspection is strictly based on the approved plan and waiver will not be granted at CSC stage. Any deviation(s) from the approved plan should be re-submitted for BP amendment and approval.

Soil Checks

NParks may conduct a physical check of the soil at the CSC stage to ensure that the quality of the planting mixture conforms to NParks' specifications for the Approved Soil Mixture (ASM). In general, such checks may be done for projects where there are new roadside green verges, or where existing roadside verges are disturbed and will be reinstated.

The soil check will be conducted on site in the presence of an NParks officer as part of the normal CSC inspection. During the inspection, the NParks officer will be checking primarily for the followings:

- Whether the roadside verge has been backfilled using ASM to the required depth
- Whether there are construction debris and/or other undesirable materials buried within the verge

In conducting the soil checks, we will require trial holes, up to 1 meter depth, to be excavated. The location of the trial holes will be selected randomly. There will be approximately 2 to 3 trial holes for every 20 meters length of roadside verge. The contractor is to provide the necessary manpower and tools to facilitate the soil check.

If the NParks officer deems that the soil check result for any stretch of the roadside verge is not satisfactory, we would require the soil for that particular stretch to be changed. Subsequent round of soil check will be conducted after the soil has been changed to ensure compliance to NParks' requirements.

Soil Laboratory Test

Soil laboratory test is a procedure in which a small sample of soil is analyzed in a laboratory for its chemical properties. The result of the test would indicate whether the soil conforms to the specifications for ASM. As a self-check measure, we strongly encourage the developer/owner to do a soil laboratory test before backfilling of the roadside green verge. This is to facilitate the CSC application and to prevent abortive work should the quality of the soil not meet NParks' requirement.

In preparing the soil sample for submission to a laboratory, you may like to take note of the following:

- Conduct the soil test a few weeks before starting work on site as the test result can take up to 2 weeks to be ready
- Collect soil samples using clean tools (spade or shovel)
- Deliver soil samples to an accredited laboratory within 24 hours

The soil sample can be submitted to any accredited laboratory for testing. A list of accredited laboratories for soil testing can be found at the Singapore Accreditation Council website. As soil preparation and submission procedures may differ across laboratories, do check with the specific laboratory for their procedures.

Acceptable and Unacceptable Horticulture Standards

The following are some examples of the acceptable and unacceptable horticulture standards.

Sapling Standards

- Girth >0.1m and height of 2.5m (clear trunk 1.5m)
- Upright and good form
- Healthy terminal shoots and free from pests, diseases and undamaged bark
- Proposed sapling should be maintained for 8 weeks or until they are well-established to NParks' satisfaction



Bark damage



Undersize girth and inadequate overall height



Poor form and slanted trunk

Instant Tree Standards

- Girth $>0.3\text{m}$
- Clear trunk $>2.0\text{m}$ (depends on species)
- Good crown form, upright straight trunk and established new shoots
- Undamaged bark, free from diseases and pests
- Proposed sapling should be maintained for 8 weeks or until they are well-established to NParks' satisfaction



Poor form/not upright/
no balance crown with foliage

Shrub Standards

- Appropriate height at least 0.5m tall
- Spacing of 0.3m to 0.5m centre to centre
- Soil depth (ASM) of at least 0.6m
- Planting bed top-dress with mulch
- Proposed plants should be maintained for 4 weeks or until they are well-established to NParks' satisfaction



Sparse planting bed



Bare/sparse planting bed

Staking and Tree Collar Standards

Staking

- 25mm galvanized steel pipe with plastic cap
- Firm
- 200mm away from tree collar
- PVC tubed nylon string

Tree Collar Protector

- PVC tube of length 200mm, diameter 75mm and thickness 2mm with slit cut



Improper staking (too close to tree)



Untidy staking/
not firmly fastened to tree

Mulching Standards

- All weeds at the plant base are to be removed before spreading the mulch
- Mulch should be forked slightly into the soil and should not be heaped up into a mound more than 100mm thick
- Mulch materials should not come into contact with the root collar of the tree
- Mulches shall be an approved friable and composted organic material such as wood chips, oil palm husks, oil palm kernels, organic compost or an approved mix



No mulching & poor staking



Poor mulching

Turf Standards

- Closed-turf with 50mm thick *Axonopus compressus* (cow grass)
- No bare patches
- No uneven ground, depressions and potholes
- No weeds and construction debris
- Turf should be established
- All turfing shall be regularly watered, weeded and maintained until growing satisfactorily in the opinion of the Board



Stone & bare patches

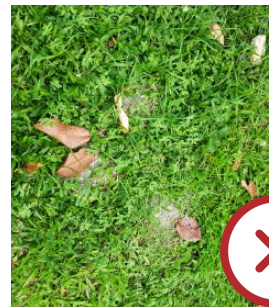

Weeds/wrong grass species



Dead turfing



Top-up soil not settled



CHAPTER

- 8 Submission Procedures
- 9 Self-Declaration Scheme
- 10 Appendices

8 SUBMISSION PROCEDURES

The submission procedures serve as a guide for consultants to prepare the necessary plans and documents for submission to NParks. To facilitate assessment and approval of your application, we would like to advise consultants to ensure that all plans and documents are in order prior to submission through the e-Corenet submission.

Building Works Not Requiring NParks' Approval at the Development Control and Certificate of Statutory Completion stages

In our continued effort to streamline the application process, we have identified the following building works that do not require NParks' approval during the DC and CSC stages. Consequently, QPs do not need to submit NParks' approval for these works for your TOP/CSC application to BCA.

Type of Building Works

Replacement or changing into $\frac{3}{4}$ full height non-PVC windows in non-conserved HDB flats



Installation of clothes drying racks (non pole-hole type)



Installation of overhead cranes (guide rails) not affecting the roof/roof gutters, not beyond the existing building footprint and not encroaching into the regulated planting areas



Type of Building Works (cont'd)

New lift shaft and lift car within detached, semi-detached and terrace houses not exceeding 3-storeys or 3 levels, including basement and attic, not involving roof works and not encroaching into regulated planting areas



Erection of new cladding on existing façade not involving roof work and not affecting regulated planting areas and roadside green verges (including trees)



Erection of safety barriers within a unit overlooking a void of more than 1m



Lift car replacement within a house/building (no changes to existing lift shaft and no roof works)

Tenant fit out works within an existing building's footprint that requires approval to BCA (e.g. new internal staircase, brick walls etc.) and not affecting the regulated planting areas

One-to-one replacement of façade/cladding not involving roof work, and not affecting regulated planting areas and roadside green verges (including trees)

Pre-Submission Consultation

Pre-submission consultation is a platform for QPs to seek guidance on NParks' technical and submission requirements. QPs are encouraged to use this platform to facilitate the planning for their developments, and the subsequent DC applications.

All pre-submission consultations can be submitted via e-Corenet.

Non-Compliance Application

The non-compliance application applies for projects that cannot comply with NParks' requirements at the DC and BP submission stages.

In the effort to facilitate our assessment and approval of each non-compliance item, the QP is to adhere to the following items when filling the submission application form for each DC or BP submission:

- a. To indicate that there is non-compliance application made with respect to the development submission for NParks' assessment.
- b. To select the type of NParks' requirement appropriate to the proposed non-compliance item.
- c. To provide clear and detailed justification for the proposed non-compliance item, with reference made to relevant documents submitted to support the case.
- d. To propose alternative solutions or mitigation measures to assuage the impact of the proposed non-compliance item with reference made to the plan.

QP is to ensure that all sections of each proposed non-compliance item in the application form are duly filled. Applications that are improperly filled or incomplete will not be considered.

Please note that the non-compliance application is assessed on a case-by-case basis and approval is granted based on the merits of each case. Approval granted on the non-compliance cases should not be taken as precedence for future cases.

Application for Development Control Approval

Streamlined Application Process

As of 1 September 2020, applications to NParks at the BP stage are no longer required. The application process has been further streamlined such that both internal and external works, as well as the Planting Scheme will be assessed at the DC stage. Upon completion of work, CSC inspection (where applicable) will be done concurrently for both internal and external works and approval will be given for both.

Development Projects Submitted before 1 September 2020

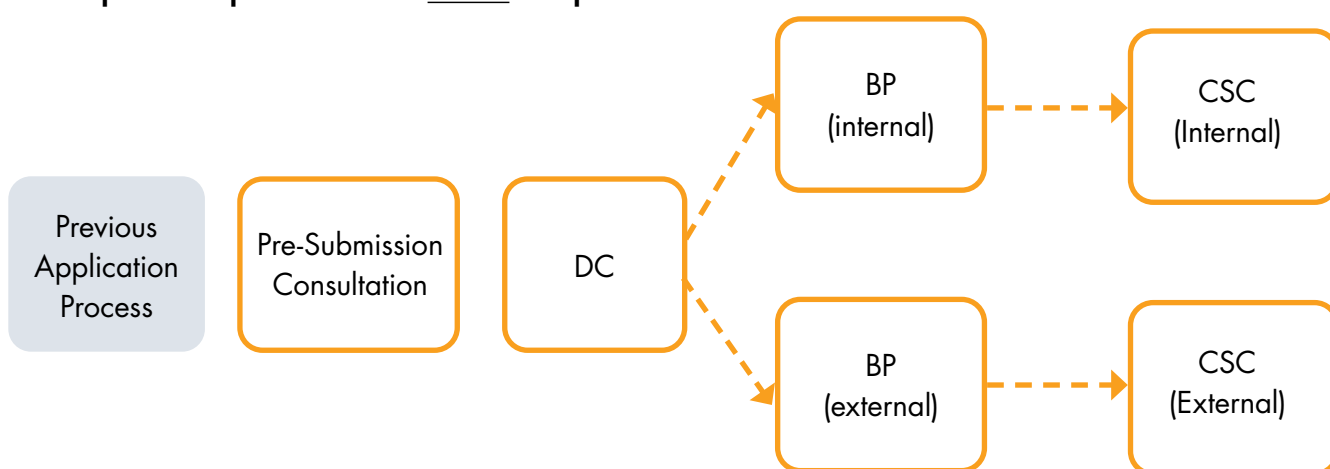

Development Projects Submitted on and after 1 September 2020



Development Projects Requiring DC Approval

Generally, NParks' DC Approval is required if your development will be:

- a. Providing new or affecting existing requisite planting areas, such as green buffers and peripheral planting verge, within the development site.
- b. Affecting existing requisite planting areas, such as green buffers and peripheral planting verges, which are within adjacent sites.
- c. Affecting/ removing trees (above 1.0m girth) within a TCA or vacant land.
- d. Affecting roadside trees, shrubs or ornamental plants due to proposed entrances or boundary walls.
- e. Affecting Heritage Road green buffers.
- f. Providing an open space as part of a landed housing development, or any other development as stipulated by URA.
- g. Proposing new or relocating existing pedestrian overhead bridge, second level link bridge or underground linkage.

Plan Submission Requirements

You are required to submit the following drawings to NParks as part of your application (refer to sample Plan A for illustration)

- a. Location plan of the development site (scale 1:10,000 or 1:5,000) showing access to the site from the road.
- b. Site plan (scale 1:500, 1:200 or 1:100).
- c. 1st storey plan (scale 1:500, 1:200 or 1:100).
- d. Basement plan (scale 1:500, 1:200 or 1:100).
- e. Roof plan (scale 1:500, 1:200 or 1:100).
- f. Cross sections and elevations (scale 1:500, 1:200 or 1:100).
- g. Survey plan (survey done less than 2 years at the point of application and endorsed by a qualified surveyor). Not applicable for Alteration & Additions proposals.

Important Note:

- a. All submission drawings should include the following details:
 - Address, lot and/or plot number of the development site and neighboring lots
 - North arrow, scale bar and legend
- b. All drawings submitted must be either in BIM Lightweight file format or CAD version and must be assigned SVY21/ Singapore TM (EPSG:3414) projected map coordinate system.**
- c. All drawings should have the layers listed in Appendix A especially the Site Boundary (SITEBNRY) layer.**

**Refer to the CAD drawing guidelines in Appendix A.

The Information Stipulated in the following Table is Applicable for All Submission Drawings

No	Information to Be Provided
1	Proposed development layout
2	Development boundary outlined in red
3	Existing and proposed road reserve line outlined in red
4	Width of existing and proposed roads
5	Category of existing and proposed roads
6	Existing and proposed roadside green verges
7	Existing and proposed levels of the development site
8	Basement line highlighted in brown dotted line
9	Existing structures to be retained are to be indicated in cyan colour
10	Proposed structures to be indicated in magenta colour
11	Existing structures proposed to be demolished to be indicated in yellow colour
12	Schematic engineering drawing with dimensions of retaining/boundary wall and foundation
13	Fire engine accessways
14	All proposed planting areas and/or green roofs (whenever applicable) are to be coloured green on the site plan and 1st storey plan
15	All proposed slopes are to be shown on the plan with standard land surveying symbols
16	Width, gradient and soil depth of the existing/reinstated/proposed green buffer/peripheral planting verges within development site
17	Allowable structures within the green buffer and peripheral planting verges are to be reflected with the size dimensions annotated
18	For each side of the development boundary, calculation of the total width of structures allowable within green buffers or peripheral verges, not exceeding 3.0m or 25% (whichever is greater) of the available road frontage or boundary, is to be shown on plan
19	Alignment, size, depth and types of existing/proposed underground services and structures (this includes the affected services and structures that require temporary or permanent diversion/relocation) that traverse through and/or within the planting areas
20	Sectional drawing of the proposed basement structures below the planting verges should be provided. Soil depth for tree planting is to be clearly shown on the sectional drawing
21	Hedge planting (only applicable to public buildings and school developments) is to be indicated on the plan with a wavy green line

Tree Information

The information of trees/palms/shrubs within the development site and along the roadside green verge should comprise the following details for submission. (refer to Sample Plan A for illustration.)

No	Information to Be Provided (Tree Information)												
1	All trees/greenery are to be uniquely numbered and reflected in their respective colours The numbering should be consistent with architectural plans (if applicable) throughout the project												
2	Species, girth and heights of existing trees within the site boundary and on the neighbouring lot up to 5.0m from the boundary should be tabulated in a table												
3	Existing roadside trees/cluster palms/shrubs abutting the development boundary and up to 10.0m on both sides of the boundary are to be indicated Any changes to the status of the existing trees approved at DC/BP stage of Architect's plan are to be reflected												
4	Colour Code for Existing Trees/Palms/Shrubs												
	<table border="1"> <thead> <tr> <th>Status of Existing Trees/Palms/Shrubs</th> <th>Outline in Colour</th> </tr> </thead> <tbody> <tr> <td>To be retained</td> <td>Green</td> </tr> <tr> <td>To be removed</td> <td>Yellow</td> </tr> <tr> <td>Removed without approval</td> <td>Red</td> </tr> <tr> <td>Removed with written approval</td> <td>Yellow (indicate the approved date in the tree schedule)</td> </tr> <tr> <td>Non-existent after investigation</td> <td>Indicate a "cross" on tree symbol</td> </tr> </tbody> </table>	Status of Existing Trees/Palms/Shrubs	Outline in Colour	To be retained	Green	To be removed	Yellow	Removed without approval	Red	Removed with written approval	Yellow (indicate the approved date in the tree schedule)	Non-existent after investigation	Indicate a "cross" on tree symbol
Status of Existing Trees/Palms/Shrubs	Outline in Colour												
To be retained	Green												
To be removed	Yellow												
Removed without approval	Red												
Removed with written approval	Yellow (indicate the approved date in the tree schedule)												
Non-existent after investigation	Indicate a "cross" on tree symbol												
5	For trees proposed for conservation, clear photographs are to be provided. The photograph should show the entire height of the trees The trees are to be numbered according to the numbering shown on the plan												

Note:

The QP/Surveyor is to obtain permission from the neighbouring owner(s) to gather the requisite tree information within the neighbouring lot(s).

Sample Plan A

Item 1 – Key and location plans of the development site



Item 2 – Tree Information

TREE NO.	TREE NAME	GIRTH (M)	HEIGHT (M)	SPREAD (M)	REMARKS
T1	Jambu Klaf	0.3	5	2	RETAINED
T2	Jambu Klaf	0.3	5	2	RETAINED
T3	Jambu Klaf	0.2	4	1	RETAINED
T4	Jambu Klaf	1.8	12	5	RETAINED
T4a	Monthor Palm	0.2	4	2	RETAINED
T5	Jambu Klaf	1.7	12	8	RETAINED
T6	Red Water Tree	1.6	15	8	RETAINED
T7	Jambu Klaf	1.8	12	8	RETAINED
T8	Jambu Klaf	2	12	4	RETAINED
T9	Yellow Sals	0.7	6	3	RETAINED
T10	Rain Tree	3.1	16	12	RETAINED
T11	Yellow Sals	0.4	9	2	RETAINED
T12	Jambu Klaf	1.2	5	1	REPL
T13	Monthor Palm	0.1	2	1	REPL
T14	Leaning	0.1	2	1	REPL
T15	Monthor Palm	0.1	2	1	REPL
T16	Rain Tree	2.3	10	10	RETAINED
T17	Jambu Klaf	1.3	8	4	REPL
T18	Jambu Klaf	1.1	8	3	REPL
T19	King Palm	0.8	5	1	RETAINED
T20	Rain Tree	2.3	12	10	RETAINED

Item 3 – Legend



Item 4 – Address, lot, and/or plot number of development site

TENURE OF LAND:	LEASEHOLD
PLANNING NO:	S.P. NO.
APPROVAL DATE:	APPROVAL DATE:
PROJECT: PROPOSED ERECTION OF A 4-STORY EXTENSION BUILDING WITH ROOF DECK AND ADDITIONS AND ALTERATIONS TO EXISTING LENG KEE COMMUNITY CENTRE ON LOTS	
000, MK OX XXX road	
DRAWING TITLE:	

Item 1

Item 2



Item 5 – Other information (i.e. location of development boundary/road reserve line, category of existing road, location/details of retaining wall, width of green buffer, location of roadside trees)



Developments with Alternative Green Buffer Configuration or Planting Area Configuration for Open Air Parking Area at Street Level Provision

In the NParks submission forms, the QP is required to inform NParks of the consideration(s) by which the development will opt for any of the following:

- a. Alternative green buffer configuration
- b. Alternative planting area configuration for open air parking area at street level

It is compulsory for projects to comply with all of the conditions stipulated under the **Alternative Green Buffer Configuration or Planting Area Configuration for Open Air Parking Area at Street Level** in the submission application for NParks approval.

The Additional Information Stipulated in the following Table is Applicable to Developments with Alternative Green Buffer Configuration

No	Information to Be Provided
1	<p>For each side of the development boundary where green buffer is to be provided, the original area of green buffer required and the final area of configured green buffer are to be annotated and tabulated on the site and 1st storey plan</p> <p>(Refer to Sample Plan B)</p>

The Additional Information Stipulated in the following Table is Applicable to Developments with Alternative Planting Area Configuration for Open Air Parking Area at Street Level

No	Information to Be Provided
1	For each row of angled or parallel parking lots, the original area of parking lots planting area and the area of configured planting area are to be annotated and tabulated on the plan (Refer to Sample Plan C Scenarios)
2	Width of all designated tree planting areas are to be indicated on the plan

Sample Plan B
(Applicable to Developments with Alternative Green Buffer Configuration)

- - - ● Total original green buffer area fronting Serangoon North Ave 5 = 84 sqm
- Total configured green buffer area fronting Serangoon North Ave 5 = 88 sqm

- a. To provide a tabulation showing total original and configured green buffer areas along the particular road frontage on the site and 1st storey plans.
- b. The total area of green buffer allowed to be configured shall not be less than the original area of green buffer required.
- c. The computation of green buffer area shall exclude area taken up by the development's access.

- d. The 3.0m wide green buffer fronting Serangoon North Ave 6 need not be computed since it is not configured.
- e. All green buffers and 2.0m wide peripheral verges are to be hatched in green on the site and 1st storey plans.

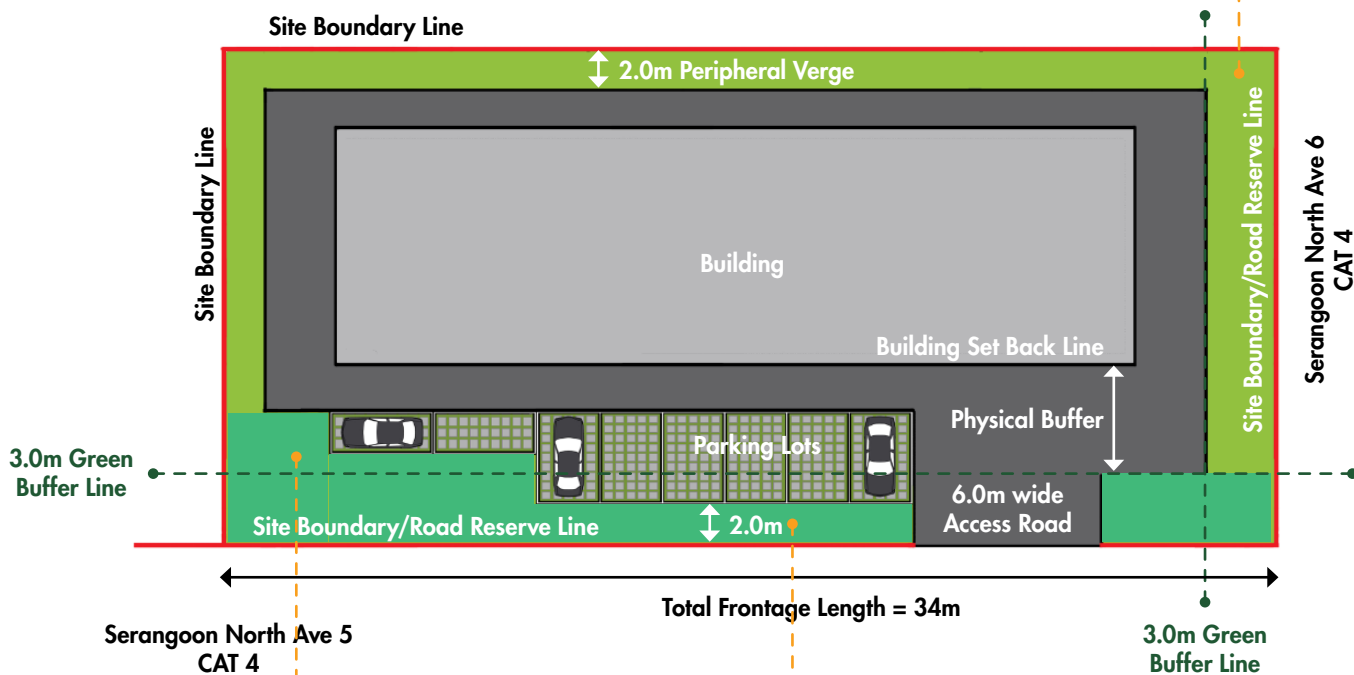

- f. To indicate the minimum 2.0m wide planting area along the particular road frontage where the green buffer will be configured.

- g. The configured green buffer shall be placed within the same side of the development boundary as the original green buffer required.

Sample Plan C

Scenario 1

Alternative Planting Area Configuration for Open Air Parking Area at Street Level for a Single Row of Parking Lots

■ Total original planting area for parking lots 1 to 5 = 24 sqm

■ Total configured planting area for parking lots 1 to 5 = 24 sqm

- To provide a tabulation showing total original and configured planting areas along the particular row of parking lots on the site and 1st storey plans.
- The parking lots numberings are to be indicated on site, 1st storey plans and the tabulation of planting areas.
- The total planting area along the particular row of parking lot allowed to be configured shall not be less than the total original planting area required.

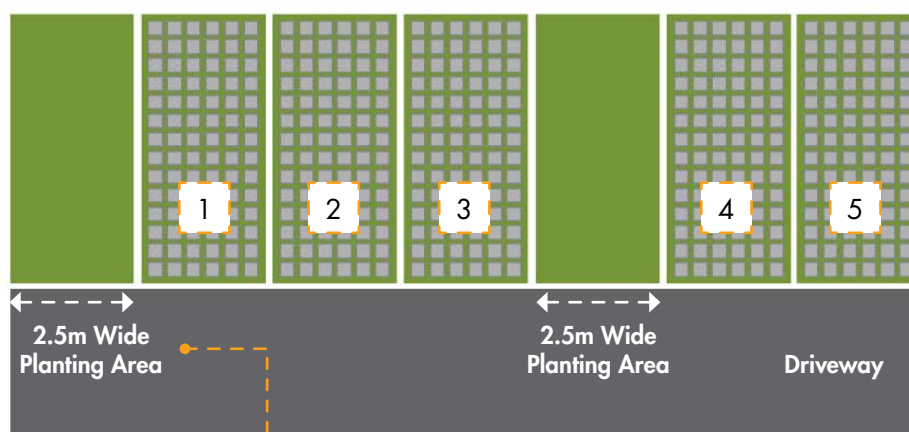

- To indicate width of planting areas designated for tree planting.
- The tree planting area must have a minimum 2.0m clear width.
- Trees are to be planted at maximum spacing of three lots width.

Sample Plan C

Scenario 2
Alternative Planting Area Configuration for Open Air Parking Area at Street Level for Two Rows of Parking Lots

- Total original planting area for parking lots 1 to 10 = 48 sqm
- Total configured planting area for parking lots 1 to 10 = 52.80 sqm

- a. To provide a tabulation showing total original and configured planting areas along the particular row of parking lots on the site and 1st storey plans.
- b. The parking lots numberings are to be indicated on site, 1st storey plans and the tabulation of planting areas.
- c. The total planting area along the particular row of parking lot allowed to be configured shall not be less than the total original planting area required.

- d. To indicate the width of planting area (min 1.0m) located along and/or between parking lots.

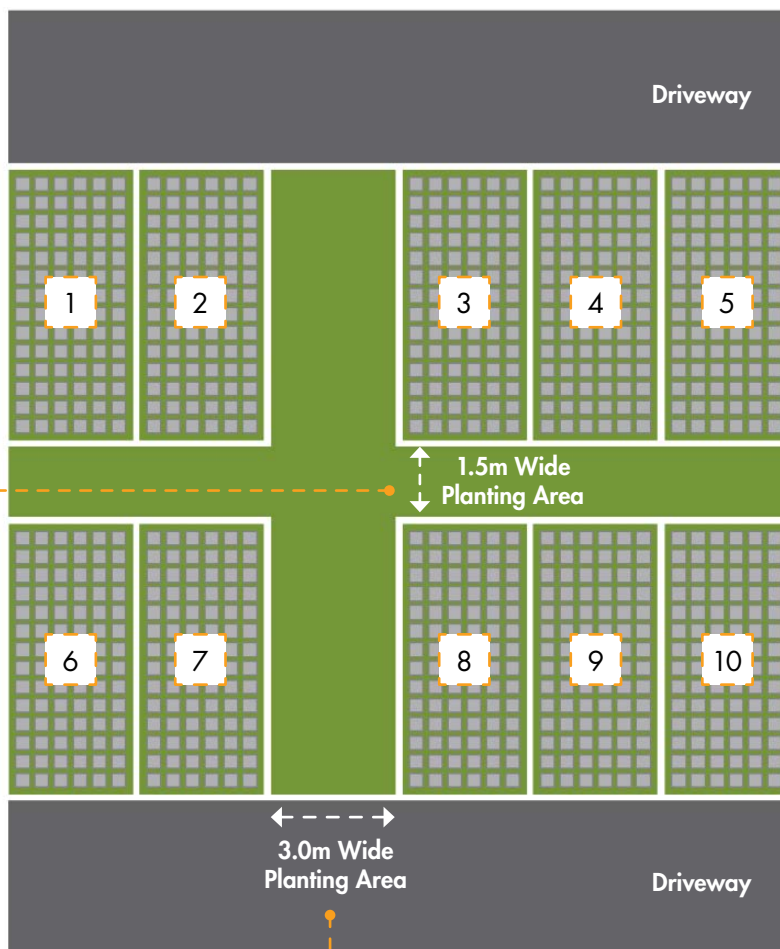

- e. To indicate width of planting areas designated for tree planting.
- f. The tree planting area must have a min 2.0m clear width.
- g. Trees are to be planted at maximum spacing of three lots width.

Sample Plan C

Scenario 3

Alternative Planting Area Configuration for Open Air Parking Area at Street Level for a Row of Parking Lots Abutting Building

■ Total original planting area for parking lots 1 to 5 = 48 sqm

■ Total configured planting area for parking lots 1 to 5 = 48.24 sqm

d. To indicate the width of planting area (min 1.0m) located along and/or between parking lots.

- To provide a tabulation showing total original and configured planting areas along the particular row of parking lots on the site and 1st storey plans.
- The parking lots numberings are to be indicated on site, 1st storey plans and the tabulation of planting areas.
- The total planting area along the particular row of parking lot allowed to be configured shall not be less than the total original planting area required.

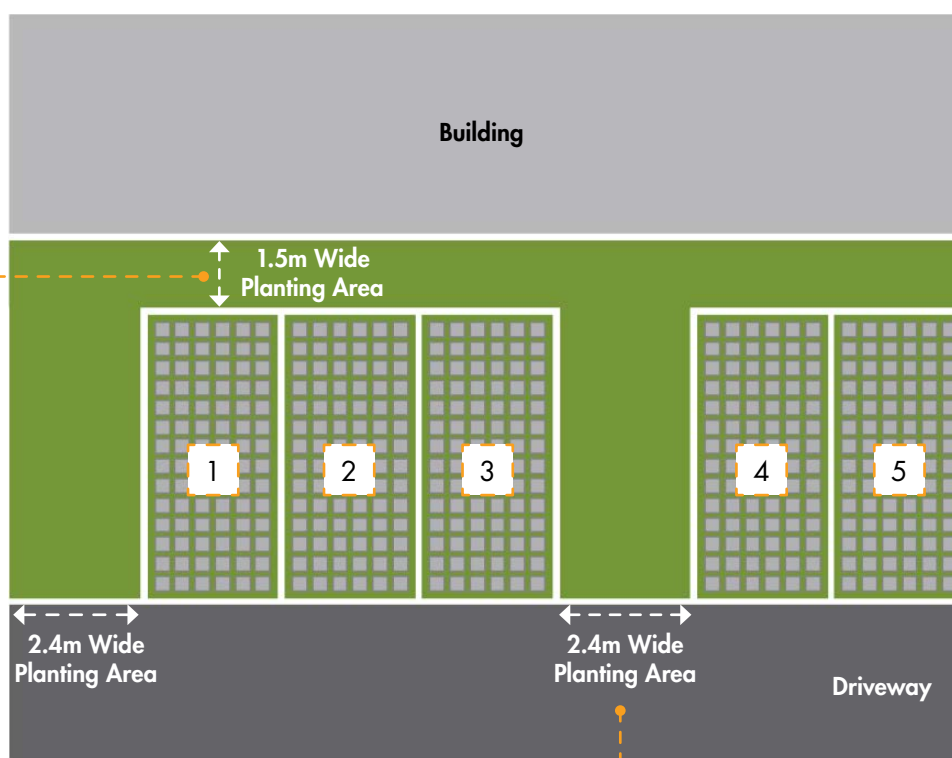

- To indicate width of planting areas designated for tree planting.
- The tree planting area must have a minimum 2.0m clear width.
- Trees are to be planted at maximum spacing of three lots.

Application for Building Plan Approval

There are two different types of BP application to NParks: BP for internal work [BP (internal)] and BP for external work [BP (external)]. Generally, BP (internal) application is for NParks' approval for requirements within the development site, whereas BP (external) application is for NParks' requirements outside of the development site, usually along the roadside.

However, as of 1 September 2020, applications to NParks at the BP stage are no longer required. The application process has been further streamlined such that both internal and external works, as well as the Planting Scheme will be assessed at the DC stage. Upon completion of work, CSC inspection (where applicable) will be done concurrently for both internal and external works and approval will be given for both.

BP (Internal)

QP will be notified through the NParks' DC approval letter to make application for NParks' BP (internal) approval for their specific development. Generally, NParks would be assessing the following:

- a. Planting scheme for the requisite planting areas such as green buffers, peripheral planting verges and open air parking planting areas.
- b. Conservation of trees (above 1.0m girth) within a TCA or vacant land.
- c. Technical requirements and planting scheme for open space, which is provided as part of a landed housing development or any other development as stipulated by URA.

BP (External)

Generally, NParks' BP (external) approval is required if your development will be:

- a. Providing new or affecting existing roadside green verges.
- b. Proposing new or removing existing roadside greenery, including trees and shrubs, which are under NParks' management.
- c. Affecting Heritage Road green buffer.
- d. Proposing new or relocating existing pedestrian overhead bridge, or any other infrastructure, which requires the provision of irrigation system to be handed over for NParks' management.

Plan Submission Requirements

You are required to submit the following drawings to NParks as part of your application (refer to Sample Plan E and Sample Plan F Landscaping Plan for illustration)

- a. Location plan of the development site (scale 1:10,000 or 1:5,000) showing access to the site from the road.
- b. Site plan (scale (1:500, 1:200 or 1:100).
- c. 1st storey plan (scale (1:500, 1:200 or 1:100).
- d. Basement plan (scale (1:500, 1:200 or 1:100).
- e. Roof plan (scale (1:500, 1:200 or 1:100).
- f. Landscaping plan (scale (1:500, 1:200 or 1:100).
- g. Cross sections and elevations (scale (1:500, 1:200 or 1:100).
- h. Survey plan (survey done less than 2 years at the point of application and endorsed by a qualified surveyor). Not applicable for Alteration & Additions proposals.

Important Note:

- a. All submission drawings should include the following details:
 - Address, lot and/or plot number of the development site and neighboring lots
 - North arrow, scale bar and legend
- b. All drawings submitted must be either in BIM Lightweight file format or CAD version and must be assigned SVY21/ Singapore TM (EPSG:3414) projected map coordinate system.**
- c. All drawings should have the layers listed in Appendix A especially the Site Boundary (SITEBNRY) layer.**

**Note: Refer to the CAD drawing guidelines in Appendix A.

Building Plan Internal (Landscaping Scheme)

The Information Stipulated in the following Table is Applicable to Landscaping Plans for Application at the BP (Internal) Stage



No	Information to Be Provided
1	All slopes are to be shown on plan using standard symbols with gradients clearly indicated on plan
2	Location and species of existing and proposed trees are to be shown on plan
3	A legend for proposed trees and shrubs is to be provided with information of species, height, girth size and quantity. To use symbols with colors to indicate different tree/shrub types
(Refer to Sample Plan E)	

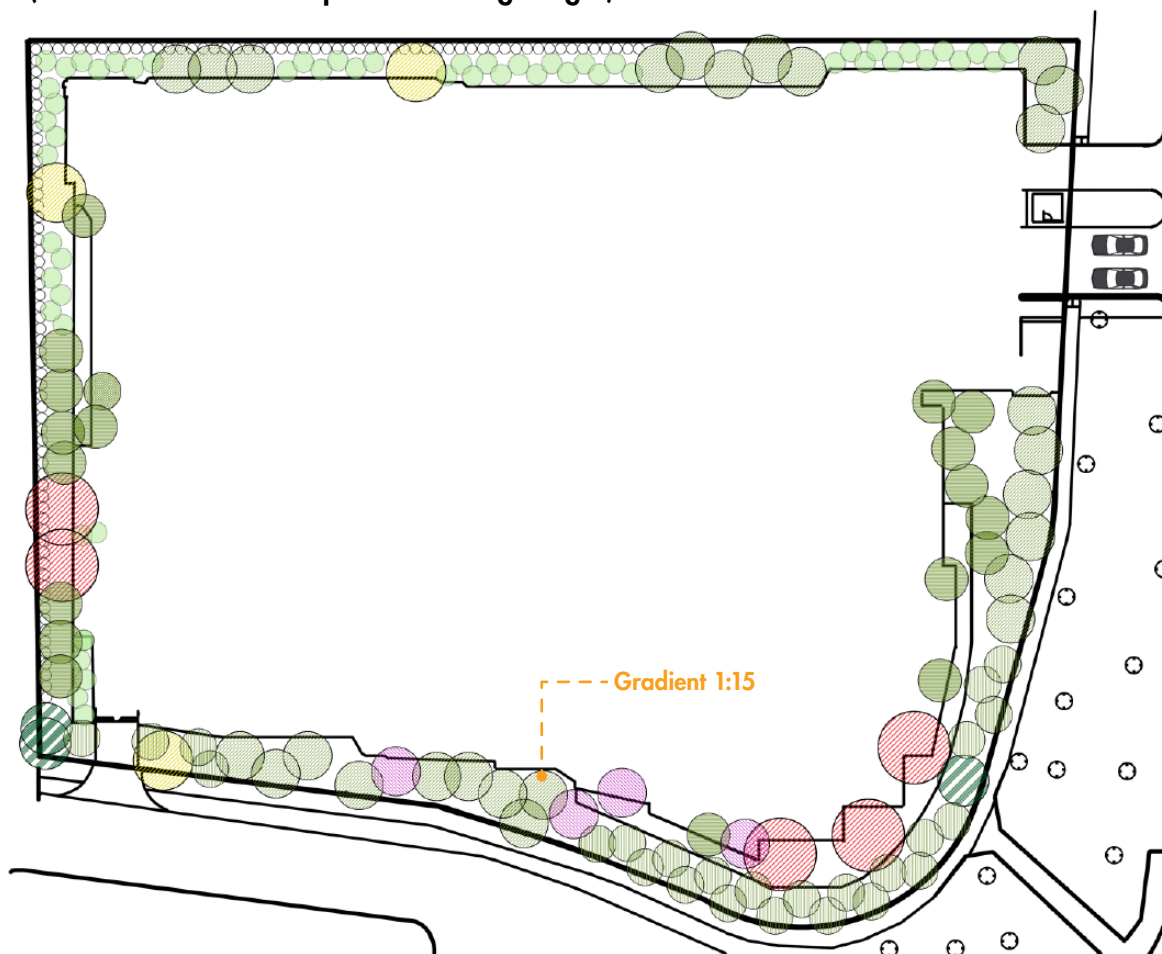

Note:

Tree planting provisions are to be provided in accordance with the stipulated guidelines or as approved at the DC stage.

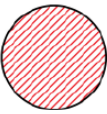
**Sample Plan E: At Grade Landscaping Plan
(Green Buffers and Peripheral Planting Verges)**

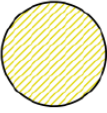

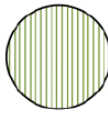
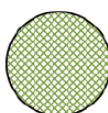
Trees	Description	Leaf Area Index (LAI)	Nos
	Brachychiton acerifolius (Australian Flame Tree) Height: 6.0m - overall Girth: 100mm - Bushy, even crown	3.0	5
	Bucida Buceras Height: 5.0m - overall Girth: 100mm - Bushy, even crown	3.0	34
	Cassia fistula (Golden Shower Tree) Height: 4.0m - overall Girth: 100mm - Bushy, even crown	2.5	4

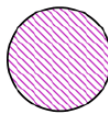
Trees	Description	Leaf Area Index (LAI)	Nos
	Gardenia carinata (Kedah Gardenia) Height: 3.0m - overall Girth: 60mm - Bushy, even crown	3.0	25
	Garcinia subelliptica (Happiness Tree) Height: 3.0m - overall Girth: 50mm - Bushy, even crown	4.0	34
	Michelia Champaka Height: 4.0m - overall Girth: 80mm - Bushy, even crown	3.0	30
	Plumeria rubra (Pink Frangipani) Height: 3.0m - overall Girth: 80mm - Bushy, even crown	2.5	10

Building Plan Internal (Open Air Parking Area at Street Level)

The Information Stipulated in the following Table is Applicable to Developments with Open Air Parking Area at Street Level and for Application at the BP (Internal) Stage

No	Information to Be Provided
1	Refer to Building Plan Internal (Landscaping Scheme) table above
2	<p>Details of the proposed green roof system and/or trellis plantings installed for the parking lots:</p> <ul style="list-style-type: none"> • Dimensions of proposed system • Type of planting species and planting medium • Details of irrigation/drainage systems • Maintenance access

Building Plan External Works

The Information Stipulated in the following Table is Applicable for all Submission Drawings for Application at the BP (External) Stage

(Refer to Sample Plan F and Cross Section G for Illustrations)

No	Information to Be Provided
1	For tree information, refer to Chapter 8 under Tree Information (Items 1 to 5)
2	Development boundary outlined in red
3	Road reserve line outlined in red
4	Existing structures to be retained are to be indicated in cyan colour
5	Proposed structures to be indicated in magenta colour
6	Existing structures proposed to be demolished to be indicated in yellow colour
7	Existing and proposed roadside green verge to be indicated in green and magenta color respectively
8	Width, gradient and soil depth of the existing/reinstated/proposed roadside green verges
9	Status (e.g. to be retained, proposed to be felled) of the conserved trees/palms/shrubs within the roadside tables if varies from DC approved drawings are to be indicated
10	Locations, dimensions and levels of footpath, roadside drain and carriageway are to be indicated
11	Location, alignment, size, depth and type of existing/proposed road elements (e.g. OG box, manholes, fire hydrant, lamppost, authorised sign etc), including underground services within the road reserve Note: The above includes affected road elements and underground services that requires temporary or permanent diversion/relocation
12	Radius of splay corners of entrance culverts and driveways
13	Proposed clearance distance from the existing/proposed trees or palms to the existing/proposed road elements are to be shown
14	For existing trees/palms on footpath, the existing unpaved areas and loose paved PC slabs around the trees/palms are to be shown
15	Proposed replacement planting scheme for the affected roadside greenery
16	Location of fire engine accessways and other proposed structures such as retaining walls and boundary walls
17	Areas under planting permit if any

Sample Plan F

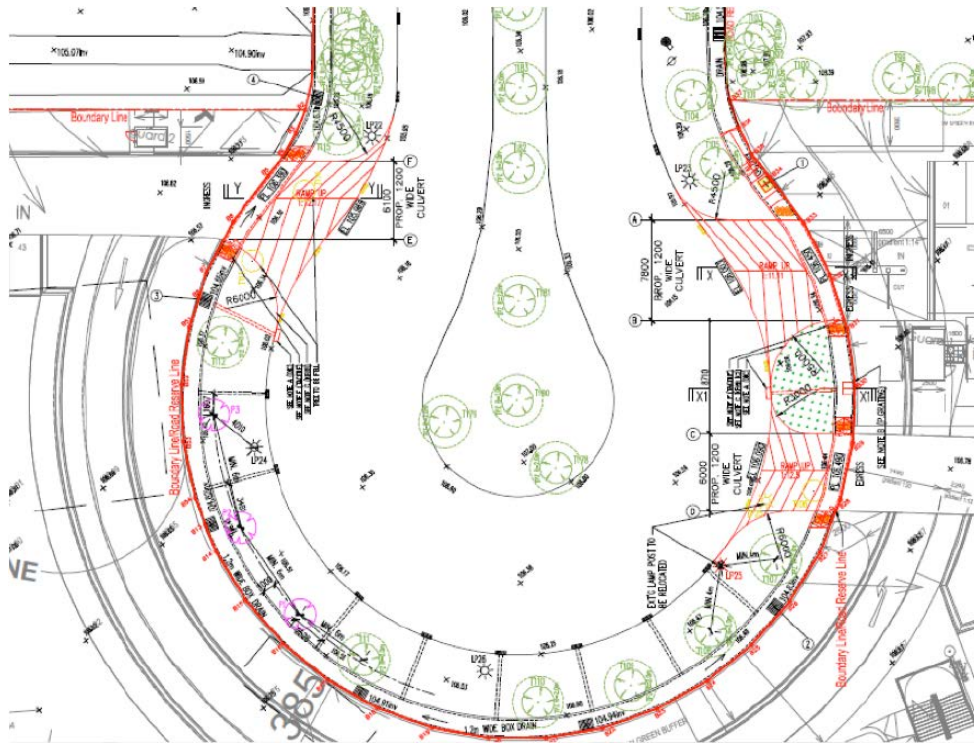

Sample Cross Section G

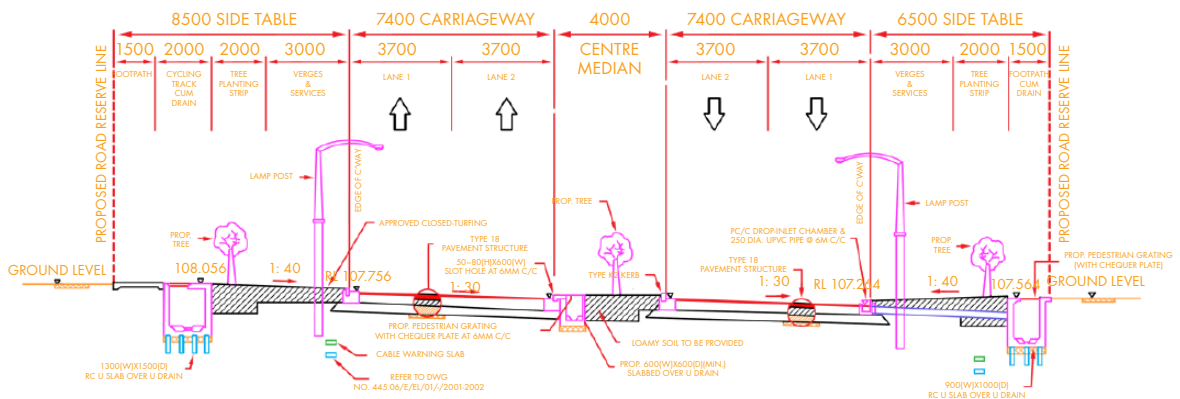

Building Plan External Works (Pedestrian Overhead Bridge, Road Viaduct, Flyover, Covered Linkway and Cycling Path)

The Information Stipulated in the following Table is Applicable to Developments with Pedestrian Overhead Bridge, Road Viaduct, Flyover, Covered Linkway and Cycling Path and for Application at the BP (External) Stage

(Refer to Sample Cross Section I, J and K)

No	Information to Be Provided
1	Road reserve line outlined in red
2	Location, dimensions, levels, gradient and proposed land take for the following existing/proposed roadside greenery, road-related facilities and infrastructures are to be indicated: <ul style="list-style-type: none"> • Footpath • Roadside drain • Roadside tree planting verge/service verge • Carriageway (at grade/depressed road portal/road viaduct/flyover) • Covered linkway (including footings) • Cycling path (including cantilevered path) • Pedestrian overhead bridge • Taxi stand and bus shelter/bay • Planter troughs along pedestrian overhead bridge, road viaduct and flyover
3	Remaining width and proposed gradient of the altered roadside green verges and green buffer of adjacent developments affected by the proposed road-related facilities and infrastructures
4	Detailed drawings of irrigation/drainage systems for the structures
5	Existing roadside green verge, green buffers of adjacent development, vacant land beyond the road reserve (turfed areas) and planter troughs along pedestrian overhead bridge/road viaduct/flyover are to be coloured green on plan
6	Existing structures to be retained are to be indicated in cyan colour
7	Proposed structures including planting area to be indicated in magenta colour
8	Existing structures including planting area proposed to be demolished to be indicated in yellow colour
9	Status (e.g. to be retained, proposed to be felled) of the conserved trees/palms/shrubs within the vacant land beyond the road reserve, green buffer of adjacent developments and roadside tables, if varies from DC approved drawings, are to be indicated
10	Planting scheme (including replacement planting scheme for the affected roadside greenery) for the roadside green verges and planter troughs along pedestrian overhead bridge/road viaduct/flyover

Sample Plan I: Showing the Alignment of Pedestrian Overhead Bridge

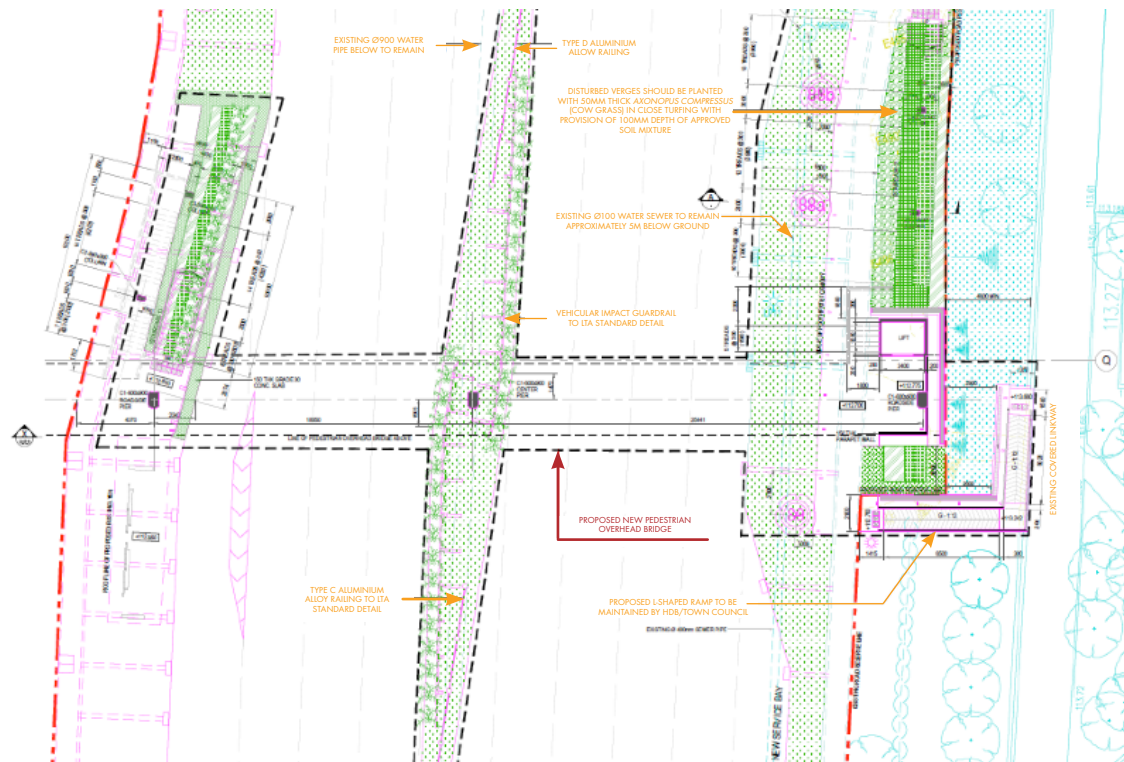

Sample Plan J: Showing the Planting Scheme along the Planter Troughs

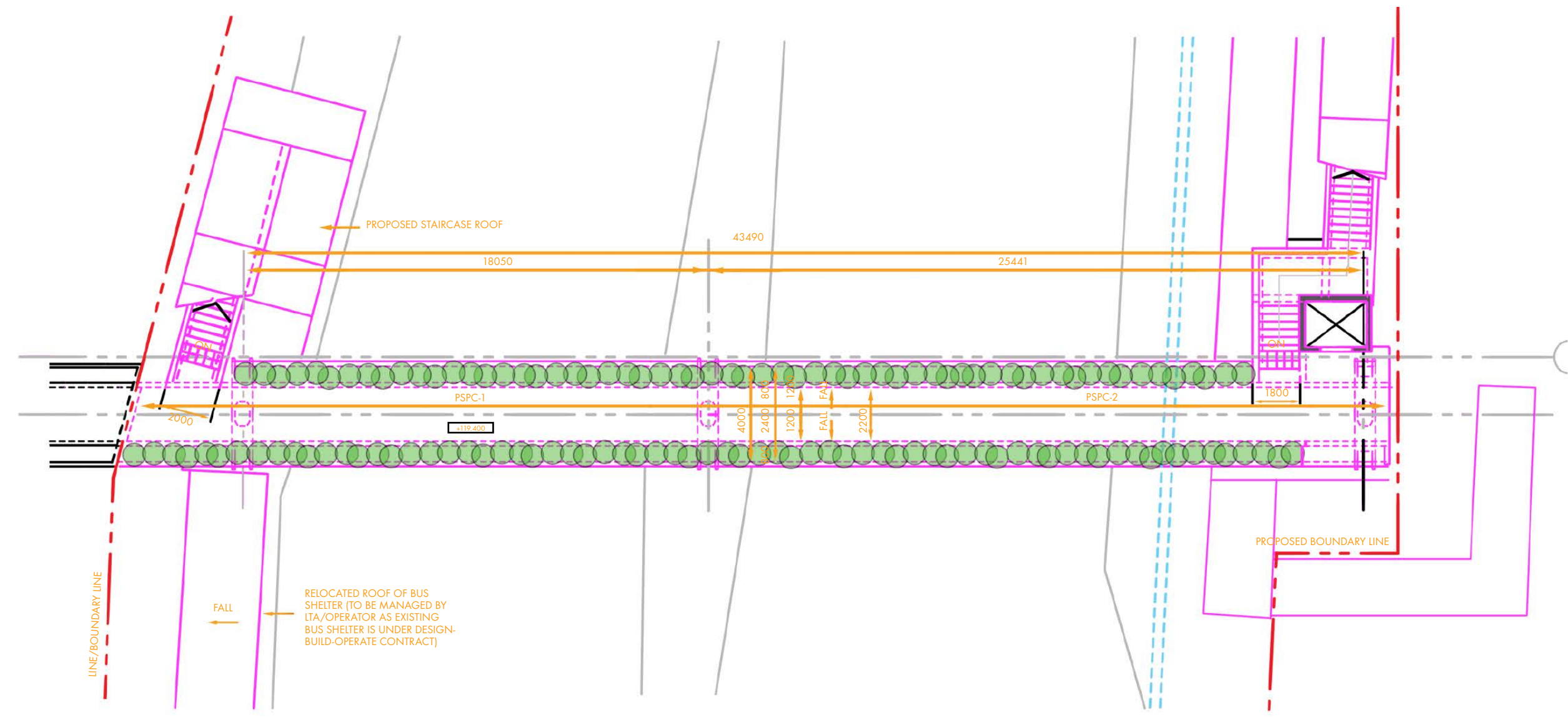

Proposed Shrub Planting Scheme

Legend	Height (mm)	Spacing (mm)	Name of Shrub Species	Bushy	Flowering	Full Form
	400	300	<i>Ixora Super Pink</i>			
	200	250	<i>Phyllanthus cochinchensis</i>			
	600	300	<i>Jatropha spp</i>			
	200	250	<i>Philodendron yellow</i>			

Legend	Height (mm)	Spacing (mm)	Name of Shrub Species	Bushy	Flowering	Full Form
	400	250	<i>Pseudomussaenda flava</i>			
	300	250	<i>Duranta 'Dark purple'</i>			
	500	300	<i>Ficus Macrocarpa Gold</i>			

Sample Cross Section K: Showing the Dimensions and Proposed Land Take for the Cycle Path

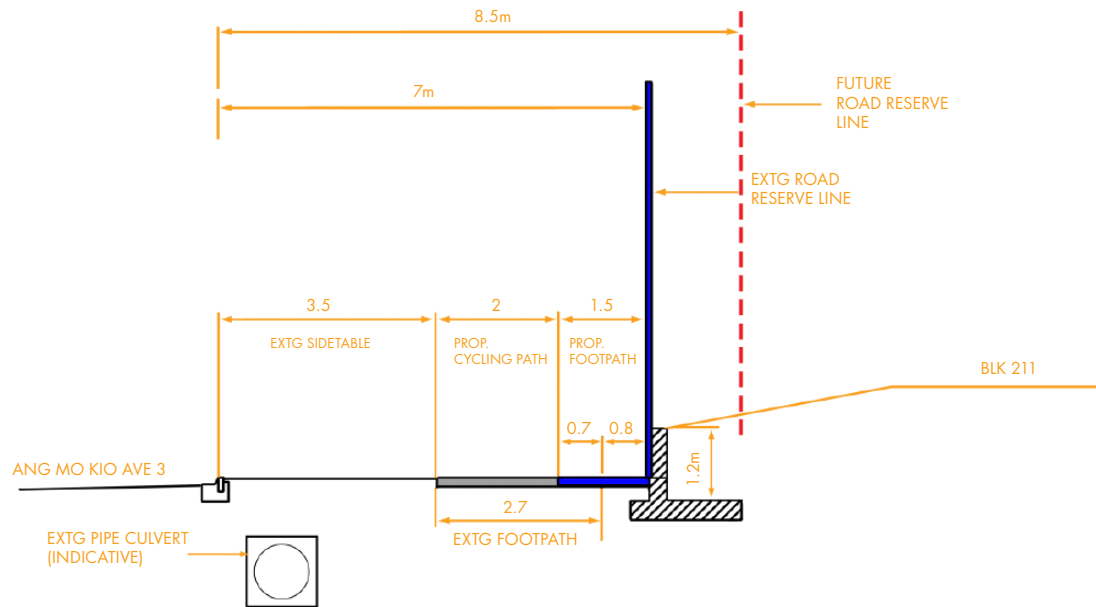

Application for Certificate of Statutory Completion

NParks' DC/BP approval will indicate whether the application for NParks' CSC approval is required. When the development works are completed, QP may request for an inspection for the completed greenery provision and plantings. CSC approval will be issued when the completed works are in accordance with the approved plan/s and meet NParks' requirements.

CSC inspection is strictly based on the approved plan/s and waiver will not be granted at CSC stage. Any deviation(s) from the approved plan/s should be re-submitted for BP amendment and approval.

Plan Submission Requirements

You are required to submit the following drawings and documents to NParks as part of your application:

- a. As-built drawings of the development (scale 1 : 500, 1 : 200 or 1 : 100)
- b. Photos of reinstated site/s and proposed planting verges/trees.
- c. Catalogues of the installed materials, frictional loss and flow rate calculations for structures (e.g. pedestrian overhead bridge) which requires the provision of irrigation system to be handed over to NParks.
- d. For vesting of Open Space:
 - Latest URA written permission
 - Certified copy of URA approved plan
 - Certified land sub-division plans
 - As-built plan of the open space
 - Handing over of hardscapes works form
 - Handing over of horticulture works form
 - 3 sets of Operation and Maintenance Manual (OMM)

Important Note:

- a. All submission drawings should include the following details, where appropriate:
 - Address, lot and/or plot number of the development site and neighboring lots
 - North arrow, scale bar and legend
 - Size and quantity of trees
 - Length and quantity of shrubs
 - Area of new turf (in hectare)
- b. All drawings submitted must be either in BIM Lightweight file format or CAD version and must be assigned SVY21/ Singapore TM (EPSG:3414) projected map coordinate system.**
- c. All drawings should have the layers listed in Appendix A especially the Site Boundary (SITEBNRY) layer.**

**Note: Refer to the CAD drawing guidelines in Appendix A.

Sample Form — Non-Compliance Application

Item a. →

Compliance of NParks Greenery Requirement	
Are you opting for alternative configuration of green buffer and/or open air parking areas at street level planting area (i.e modifying the dimension of planting area provision to provide area for area replacement)?	
<input type="radio"/> Yes <input type="radio"/> No <input checked="" type="radio"/> Not Applicable	
Do you have to make application for approval of any non-compliance to NParks greenery requirements?	
<input checked="" type="radio"/> Yes <input type="radio"/> No <input type="radio"/> Not Applicable	

Item b. →

Item c. →

Item d. →

Non-Compliance of NParks Requirements	
Type of Non-Compliance	Please Select
Justification(s) Note: Please make clear reference to supporting document(s) attached in your submission	
Compensation & Alternative Provision(s) Note: Please make clear reference to supporting document(s) and/or plan drawing(s) attached in your submission	
<input type="button" value="Add"/> <input type="button" value="Delete"/>	

9 SELF-DECLARATION SCHEME

The Self-Declaration (SD) scheme serves to streamline and facilitate applications to NParks at the DC, BP and CSC stages. In making an application to NParks via this scheme, proposed works are checked and declared by the QP to be in full compliance with NParks' requirements as stipulated in prevailing regulations and guidelines. With this, the time required for applications to be cleared by NParks can be reduced.

Qualifying Developments

To qualify for the SD scheme, the proposed development **must** meet the eligibility conditions as set out in the subsequent sections on DC, BP for internal work [BP (internal)], BP for external work [BP (external)] and CSC applications via the SD scheme.

Submission Procedures

If you are making an application to NParks at the DC stage via the SD scheme, it is mandatory for subsequent applications at the BP (internal) and CSC for internal work [CSC (internal)] stages to be done through the SD scheme. The relevant application fee will apply. Please refer to the submission procedures as shown in the following flowchart:

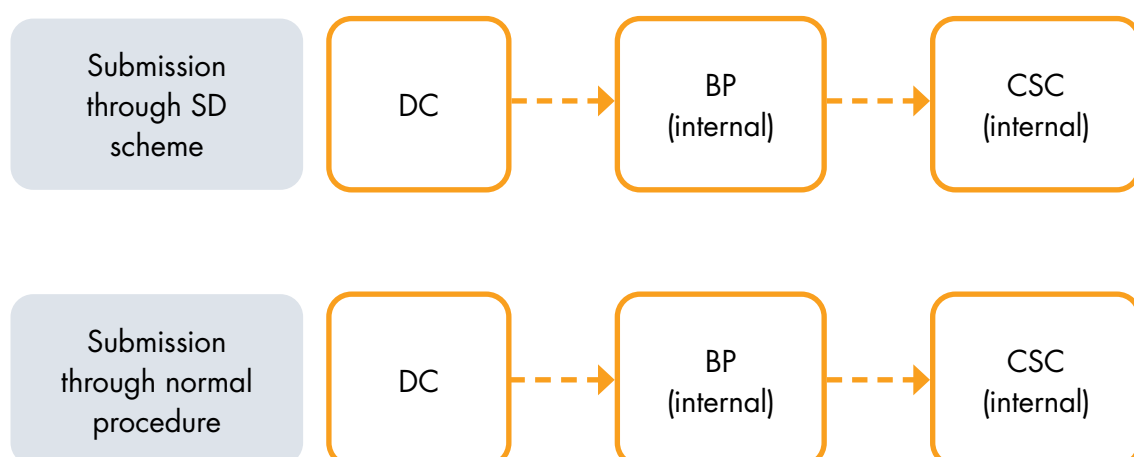

Application to NParks at the BP (external) stage can be done either through the normal procedure or SD scheme, regardless of the application mode at the DC stage. However, once a particular mode of application is undertaken at the BP (external) stage, you must follow through the same application mode for the subsequent application at the CSC for external work [CSC (external)] stage. The relevant application fee will apply. Please refer to the submission procedures as shown in the following flowchart:

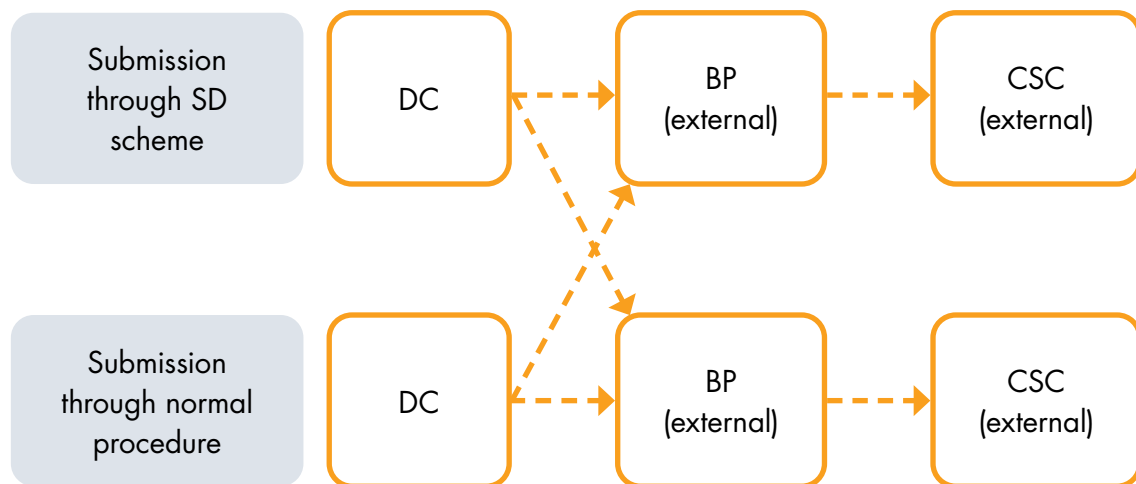

Submission Requirements

The QP is required to:

- a. Submit the SD application form – please ensure that the form is duly and fully completed.
- b. Attach the necessary plans. Please refer to the plan submission requirement for DC, BP and CSC application in Chapter 8, **Submission Procedures**.

Rejection of Application

Please note that applications made under the SD scheme **will be rejected**, without refund of the application fee, if:

- a. The SD application form is incomplete or incorrectly filled out.
- b. The eligibility conditions for application via the SD scheme are not met.
- c. The necessary plans are not submitted.
- d. The proposed works are not in compliance with NParks' requirements as stipulated in prevailing regulations and guidelines.

The QP will have to submit a new application, either through the normal procedure or SD scheme (whichever is applicable), accompanied with a new application fee.

Please note that NParks takes a serious view on false declarations, and reserves the right to take further action (including prosecutorial action) against any QP, developer or any other person connected with the false declaration found to be doing so.

Application for DC Approval

Eligibility Conditions

You will be eligible to apply through the SD scheme, unless your development falls under the following category:

- a. Development with Heritage Tree within the site
- b. Development along Heritage Road
- c. Development is abutting or within a Nature Reserve or Nature Area
- d. Development required by NParks or competent authority to carry out Biodiversity Impact Assessment (BIA) or Environmental Impact Assessment (EIA)
- e. Development with new pedestrian overhead bridge or proposed building works to existing pedestrian overhead bridge
- f. Development required by competent authority to provide open space, pedestrian mall or promenade
- g. Development with new road proposal under Street Work Act

To qualify for the SD scheme, the development must also fulfil one criteria in every section (A through G).

Section A

Trees/Single Stem Palms within Development Site

1. The development is located within a Gazetted TCA or vacant land, and all trees/single stem palms located within the development site are either less than or equal to 1.0m in girth. The girth of the tree shall be measured 1.0m from the ground. Recent photographs showing clear view of all the trees/single stem palms within the site shall be submitted

OR

2. The development is located within a Gazetted TCA or vacant land, and there is no tree/single stem palm within the development site. Recent photographs showing clear view of the site shall be submitted

OR

3. The development site is not located within either a TCA or vacant land

Section B

Green Buffer and Peripheral Planting Verge

1. Provision of green buffer and peripheral planting verge are not required within the boundary of the development site

OR

2. Existing green buffer and peripheral planting verge located within the development will not be altered or affected by the proposed development works

OR

3. Green buffer and peripheral planting verge in the development have been provided in accordance with the requirements in Chapter 3, **Greenery Provisions within Premises**. Trees will be planted at a maximum distance of 6.0m from each other. The girth of the proposed trees shall be at least 0.1m

Section C

Open Air Parking Area at Street Level

1. No open air parking area at street level within the development site

OR

2. Existing planting areas within existing open air parking areas at street level will not be affected by the proposed development works

OR

3. Planting areas to parking lots have been provided in accordance with the requirements in Chapter 3, **Greenery Provisions within Premises**. Trees will be planted at a maximum distance of 6.0m from each other. For open air parking area at street level using alternative planting area configuration, trees will be planted up to a maximum spacing of three lots width for angled parking or two lots length for parallel parking. The girth of proposed trees shall be at least 0.1m

Section D

NParks' Terms and Conditions for Government Land Sale Site

1. The development site is a government land sale site. The development will comply with NParks' terms and conditions for the land sale, including those for conservation of trees

OR

2. The development site is not a government land sale site.

Section E

Park and/or Park Connector under NParks' Management

1. The development site is abutting existing park and/or park connector under NParks' management. The park and/or park connector will not be affected by the development works, and there is no proposed new access (e.g. side gate) to the park and/or park connector

OR

2. The development site is not abutting existing park and/or park connector under NParks' management.

Section F

Trees/Single Stem Palms within Neighbouring Lots

1. Adjacent lot is located within a TCA or is a vacant land, and all trees/single stem palms within the lot, up to a distance of 5.0m from the development boundary, are either less than or equal to 1.0m in girth. The girth of the tree shall be measured 1.0m from the ground

OR

2. Adjacent lot is located within a TCA or is a vacant land, and there is no tree/single stem palm within the lot, up to a distance of 5.0m from the development boundary

OR

3. Adjacent lot is not located within Tree Conservation Area or vacant land

Section G

Roadside Trees/ Single Stem Palms

1. No roadside tree/single-stem palm along the development site

OR

2. All existing roadside trees/single-stem palms along the development site are less or equal to 1.0m girth. No roadside tree/single-stem palms will be affected, or only a maximum of two numbers of roadside trees/single-stem palms, which are of girth less than 0.5m, will be affected by the development works. All proposed development works within the road reserve will be conducted at a minimum distance away from all other retained roadside trees/single-stem palms as shown in the table below:

Girth of Roadside Tree	Girth of Single Stem Palm	Minimum Clear Distance from Proposed Development Works within Road Reserve
Less than or equal 0.5m	-	1.5m
More than 0.5m but less than or equal 1.0m	-	2.5m
-	Less than or equal 1.0m	1.0m

Plan Submission Requirement

- Location plan of the development site (scale 1:10,000 or 1:5,000) showing access to the site from the road.
- Site plan (scale 1:500, 1:200 or 1:100).
- 1st storey plan (scale 1:500, 1:200 or 1:100).
- Basement plan (scale 1:500, 1:200 or 1:100).
- Roof plan (scale 1:500, 1:200 or 1:100).
- Cross sections and elevations (scale 1:500, 1:200 or 1:100).
- Survey plan (survey done less than 2 years at the point of application and endorsed by a qualified surveyor). Not applicable for Alteration & Additions proposals.

Application for BP for Internal Work Approval

Eligibility Conditions

You will be eligible to apply through the SD scheme, unless your development falls under the following category:

- a. Development with Heritage Tree within the site
- b. Development along Heritage Road
- c. Development is abutting or within a Nature Reserve or Nature Area
- d. Development required by NParks or competent authority to carry out BIA and EIA
- e. Development with new pedestrian overhead bridge or proposed building works to existing pedestrian overhead bridge
- f. Development required by competent authority to provide open space, pedestrian mall or promenade

Note:

The QP can only apply for BP (internal) approval via the SD scheme if DC for the same project has been approved under the SD scheme.

To qualify for the SD Scheme, the development must fulfil one criteria in every section (A through F).

Section A

Trees/Single Stem Palms within Development Site

1. The development is located within a Gazetted TCA or vacant land, and all trees/single stem palms located within the development site are either less than or equal to 1.0m in girth. The girth of the tree shall be measured 1.0m from the ground. Recent photographs showing clear view of all the trees/single stem palms within the site shall be submitted

OR

2. The development is located within a Gazetted TCA or vacant land, and there is no tree/single stem palm within the development site. Recent photographs showing clear view of the site shall be submitted

OR

3. The development site is not located within either a TCA or vacant land

Section B

Green Buffer and Peripheral Planting Verge

1. Provision of green buffer and peripheral planting verge are not required within the boundary of the development site

OR

2. Existing green buffer and peripheral planting verge located within the development will not be altered or affected by the proposed development works

OR

3. Green buffer and peripheral planting verge in the development have been provided in accordance with the requirements as described in Chapter 3, **Greenery Provisions within Premises**. Trees will be planted at a maximum distance of 6.0m from each other. The girth of the proposed trees shall be at least 0.1m

Section C

Open Air Parking Area at Street Level

1. No open air parking area at street level within the development site

OR

2. Existing planting areas within existing open air parking areas at street level will not be affected by the proposed development works

OR

3. Planting areas to parking lots have been provided in accordance with the requirements in Chapter 3, **Greenery Provisions within Premises**. Trees will be planted at a maximum distance of 6.0m from each other. For open air parking area at street level using alternative planting area configuration, trees will be planted up to a maximum spacing of three lots width for angled parking or two lots length for parallel parking. The girth of proposed trees shall be at least 0.1m

Section D

NParks' Terms and Conditions for Government Land Sale Site

1. The development site is a government land sale site. The development will comply with NParks' terms and conditions for the land sale, including those for conservation of trees

OR

2. The development site is not a government land sale site.

Section E

Park and/or Park Connector under NParks' Management

1. The development site is abutting existing park and/or park connector under NParks' management. The park and/or park connector will not be affected by the development works, and there is no proposed new access (e.g. side gate) to the park and/or park connector

OR

2. The development site is not abutting existing park and/or park connector under NParks' management.

Section F

Trees/Single Stem Palms within Neighbouring Lots

1. Adjacent lot is located within a TCA or is a vacant land, and all trees/single stem palms within the lot, up to a distance of 5.0m from the development boundary, are either less than or equal to 1.0m in girth. The girth of the tree shall be measured 1.0m from the ground

OR

2. Adjacent lot is located within a TCA or is a vacant land, and there is no tree/single stem palm within the lot, up to a distance of 5.0m from the development boundary

OR

3. Adjacent lot is not located within TCA or vacant land

Note:

The QP can only apply for CSC (internal) via the SD scheme if BP (internal) has been approved under the SD scheme.

Plan Submission Requirement

- Location plan of the development site (scale 1:10,000 or 1:5,000) showing access to the site from the road.
- Site plan (scale 1:500, 1:200 or 1:100).
- 1st storey plan (scale 1:500, 1:200 or 1:100).
- Basement plan (scale 1:500, 1:200 or 1:100).
- Roof plan (scale 1:500, 1:200 or 1:100).
- Landscaping plan (scale 1:500, 1:200 or 1:100).
- Cross sections and elevations (scale 1:500, 1:200 or 1:100).

Application for BP for External Work Approval

Eligibility Conditions

You will be eligible to apply through the SD scheme, unless your development falls under the following category:

- a. Development along Heritage Road
- b. Development abutting or within a Nature Reserve or Nature Area
- c. Development with new pedestrian overhead bridge or proposed building works to existing pedestrian overhead bridge
- d. Development required by competent authority to provide pedestrian mall or promenade
- e. Development with new road proposal under Street Work Act

To qualify for the SD scheme, the development must fulfil one criteria in every section (A through D).

Section A

Roadside Trees/ Single Stem Palms

1. There is no roadside tree/single-stem palm along the development site

OR

2. All existing roadside trees/single-stem palms along the development site are less or equal to 1.0m girth. No roadside tree/single-stem palms will be affected. All proposed development works within the road reserve will be conducted at a minimum distance away from all other retained roadside trees/single-stem palms as shown in the table below:

Girth of Roadside Tree	Girth of Single Stem Palm	Minimum Clear Distance from Proposed Development Works within Road Reserve
Less than or equal 0.5m	-	1.5m
More than 0.5m but less than or equal 1.0m	-	2.5m
-	Less than or equal 1.0m	1.0m

Section B

Roadside Shrubs under NParks' Management

1. There is no shrub within the roadside green verge along the development site.

OR

2. Existing shrubs within the roadside green verge along the development site will not be affected by the proposed development works.

OR

3. Existing shrubs within the roadside green verge along the development site will be affected by the proposed development works. The affected area will be reinstated with the same shrub species and in the same density as existing condition.

Section C

Roadside Green Verge

1. There is no new or existing roadside green verge along the development side.

OR

2. There is no new roadside green verge. Existing roadside green verge will also not be affected by the proposed development works.

OR

3. There is no new roadside green verge. Existing roadside green verge will be affected by the proposed development works. The roadside green verge will be reinstated with *Axonopus compressus*.

Section D

Park and/or Park Connector under NParks' Management

1. The development site is abutting existing park and/or park connector under NParks' management. The park and/or park connector will not be affected by the development works, and there is no proposed new access (e.g. side gate) to the park and/or park connector

OR

2. The development site is not abutting existing park and/or park connector under NParks' management.

Note:

The QP can only apply for CSC (external) via the SD scheme if BP (external) has been approved under the SD scheme.

Plan Submission Requirement

- Location plan of the development site (scale 1:10,000 or 1:5,000) showing access to the site from the road.
- Site plan (scale 1:500, 1:200 or 1:100).
- 1st storey plan (scale 1:500, 1:200 or 1:100).
- Cross sections and elevations (scale 1:500, 1:200 or 1:100).

Application for CSC Approval

Eligibility Conditions

You can only apply to NParks for CSC (internal) approval via the SD scheme if BP (internal) has been approved under the SD scheme. Likewise, you can only apply for CSC (external) approval via the SD scheme if BP (external) has been approved under the SD scheme.

The works must be implemented in accordance with the approved plan, and are also in compliance with NParks' requirements as stipulated in prevailing regulations and guidelines.

Submission Requirement

- Date stamped photo of reinstated site, proposed planting area and/or all proposed trees. Photos must present the trees in their entirety and should also clearly show the condition of the turf. All photos should be compiled into a file.
- Soil laboratory test results, if applicable.

10 APPENDICES

Appendix A: CAD Drawing Guidelines

In submitting CAD drawings to NParks, please abide by the following guidelines:

- a. All drawing plans are to follow the standard layering, symbol, file naming convention format C, color and line type standard and the recommended scale to use for different types of plan as defined in the Code of Practice CP83 for Construction Computer Aided Design (CAD).
- b. All drawings submitted must be assigned the use SVY21/Singapore TM (EPSG:3414) projected map coordinate system.
- c. Each CAD file contains only one title block.
- d. Draft work and construction lines must not be included in the CAD files.
- e. Limit of the drawing in each CAD file is the same as the boundary of the title block (i.e no information is included outside the title block).
- f. There shall be only one drawing per CAD file. All drawings shall be the last saved view of the whole drawing complete with one title block.
- g. Raster images shall not be attached to the CAD file.
- h. Hatch pattern in CAD files, where applicable, are to be used in CAD drawings; legend for pattern with explanatory note shall be included in the drawing.
- i. No proprietary fonts should be used.
- j. All layers should be set to "on" in the "last saved view". No hidden CAD layers should be included in the CAD files.
- k. The CAD files should be named as shown in the following File Naming convention.

File Naming

File Naming convention as indicated should be used (e.g. DTL3 for Downtown Line 3):

Project ID					Originator		Type of Work		Level/ View Plane		Zone		Version		User-Defined
D	T	L	3	-	C	-	S	P	-	-	-	-	A	-	NPARKS

Project Identification

User-defined field. E.g. DTL3 for Downtown Line 3.

Originator		Level	View Plane
A	Architect	O2	2 nd storey
C	Civil Engineer	B2	Basement 2
L	Land Surveyor	E2	Elevation 2
		R	Roof
		-	Whole project/Site plan

Type of Work

SP	Site plan (if the submission contains only one CAD file with all details such as site layout and floor layout, then Type of Work should be indicated as SP)
FP	Floor plan (if the CAD file contains floor layout and “section and/or elevation drawing”, then Type of Work should be indicated as FP)
FE	Floor plan — elevation view (if the CAD file contains section and elevation drawing, then Type of Work should be indicated as FE)
FX	Floor plan — cross section view
SX	Site cross section view
SE	Site elevation view
SV	Survey plan
TP	Topo plan
LS	Landscaping
OA	Other ancillary structure (e.g. bin centre, guard house, bulk meter, etc.)

Zone or Block

O1	Block 1
A1	Zone A1
-	All blocks

Version (Revision/Submission)

A	1 st submission
B	2 nd submission
C	3 rd submission

- I. The CAD files should be prepared in accordance to the layers as shown in the following.

*Note:
Submitted Site Plans must have Site Boundary (SITEBNRY) layer.

List of Layers to be Extracted for Submission to NParks

Element Name	Description of Elements
LNSPETRE	Existing Tree
LNSPEPAL	Existing Palm
LNSPESHB	Existing Shrub
LNSPEHED	Existing Hedges
LNSPPTRE	Proposed Tree
LNSPPPAL	Proposed Palm
LNSPESHB	Proposed Shrub
LNSPPHED	Proposed Hedges
LNSPETURF	Turfing
LNSPARTN	Aeration Area
LNSPBUFF	Green Buffer
PRGDOUTL	Open Space Outline
PRGDCALC	Open Space Size Calculation
LNSPVERG	Planting Verge
LNSPGRAD	Planting Verge Gradient
SITE----	Site, External Works
SITECADA	Cadastral Information
SITEBNRY*	Site Boundary*
SITEKPLN	Key Plan
SITENRTH	North Point
SITEBASE	Basement Outline
SITEWALL	Boundary Wall

Element Name	Description of Elements
SITEBLDG	Building Outline
SITESTBK	Building Setback
SITEDRAN	Drain
SITE----	Diversion of Existing Services
ROADVERG	Roadside Planting Verge
ROADCPRK	Open Carparks
ROADWIDL	Road Reserve Line
ROAD----	Roadways
SDRN----	Roadside Drain, Scupper Drain/pipe
SDRNRESV	Drainage Reserve
PATH----	Footpaths, Walkways
PATHWALK	Covered Walkways
CPRK---	Covered Carparks
RETWWALL	Retaining Wall
BRDG----	Covered Overhead Bridge
ANOT----	Annotations for Entire CAD Sheet Including Texts, Dimensions
ANOTENDO	Plan Endorsement
ANOTGRID	Grids
ANOTTBLK	Title Block

Appendix B: Specified Premises Exempted from the Provision of Green Buffers and Peripheral Planting Verges

The following developments are exempted from the provision of green buffers and peripheral planting verges within their premises.

1. House numbers 263, 265, 267, 269, 271, 273, 275, 277, 279, 281, 281A, 283, 283A, 285, 287, 287A, 289 and 289A at Holland Road, and which are more particularly delineated in Map 1.

MAP 1



2. House numbers 15, 37, 41, 43, 45, 47, 49, 67, 75, 81, 85, 87, 95, 101 and 103 at Beach Road, and which are more particularly delineated in Map 2.
3. House numbers 402, 408, 410, 420, 452, 460, 470, 490, 492, 494, 496, 516, 520 and 530 at North Bridge Road, and which are more particularly delineated in Map 2.
4. House numbers 21, 31, 33, 37, 41, 51 and plots TS12-00530A, TS12-98507X, TS12-98514W, TS12-98512C, TS12-98511L, TS12-98531W, TS12-98506N, TS12-98503T, TS12-98496N, TS12-98498L, TS12-98497X, TS12-98489P, TS12-98492P, TS12-00478M, TS12-00388C, TS12-00389M, TS12-00390L, TS12-98439W, TS12-98441M, TS12-98442W, TS12-98446A, TS12-98447K, TS12-98448N, TS12-98440C, TS12-00832L, TS12-00831X, TS12-00860K, TS12-00739X, TS12-00859X, TS12-98458P, TS12-00884V, TS12-98530M, TS12-98505K, TS12-98502P, TS12-98499C, TS12-98493T, TS12-98488V, TS12-00951X, TS12-98455M, TS12-00386X, TS12-98483X, TS12-98482N, TS12-98481K, TS12-98454C, TS12-98473W, TS12-00747V, TS12-00529N and TS12-00687M at Middle Road, and which are more particularly delineated in Map 2.
5. House numbers 25, 26, 27, 28, 29, 30, 31, 32, 33, 34, 35, 36, 38, 39 and 41 at Seah Street, and which are more particularly delineated in Map 2.

MAP 2

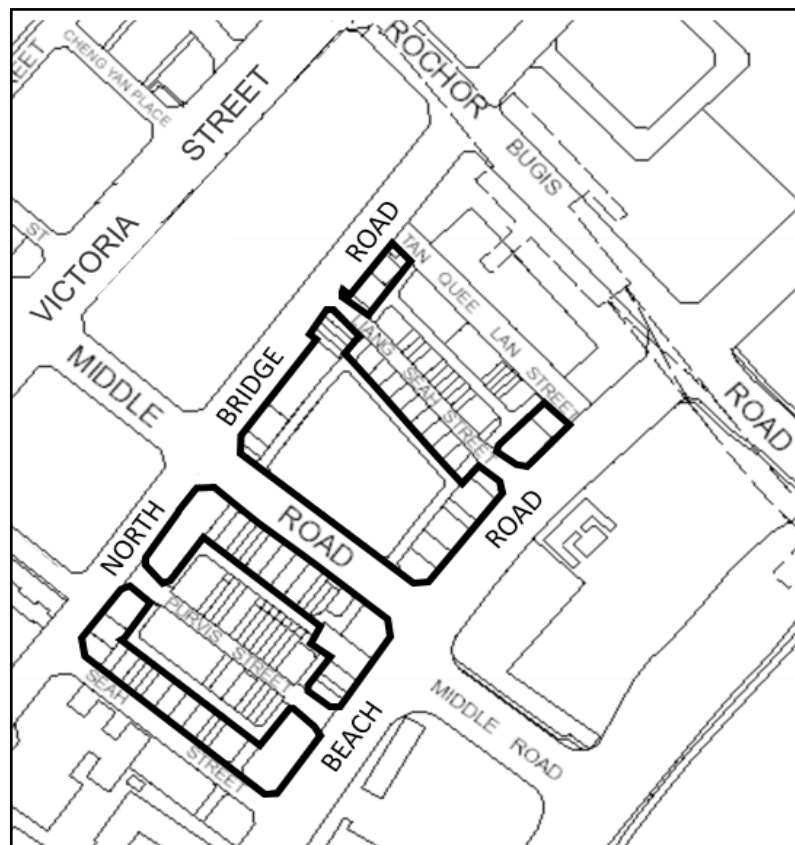

6. House numbers 87, 89, 91, 93, 95, 97, 99, 101, 103, 105 and 107 at Emerald Hill Road, and which are more particularly delineated in Map 3.
7. House numbers 32, 34, 36, 38, 40, 42, 44, 46, 48, 50, 52, 54 and 56 at Saunders Road, and which are more particularly delineated in Map 3.

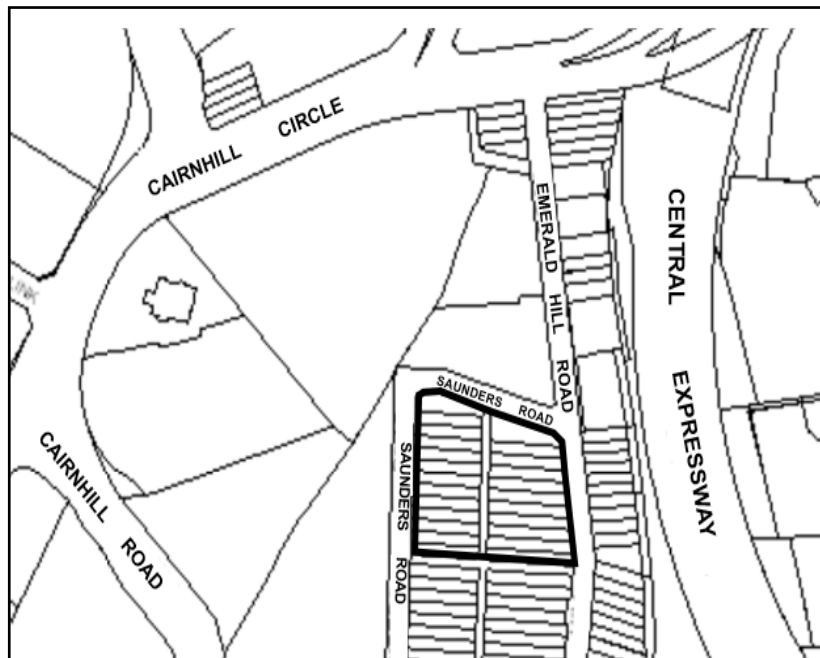
MAP 3

8. House numbers 231, 233, 235, 237, 239, 241 and 243 at Cantonment Road, and which are more particularly delineated in Map 4.

MAP 4

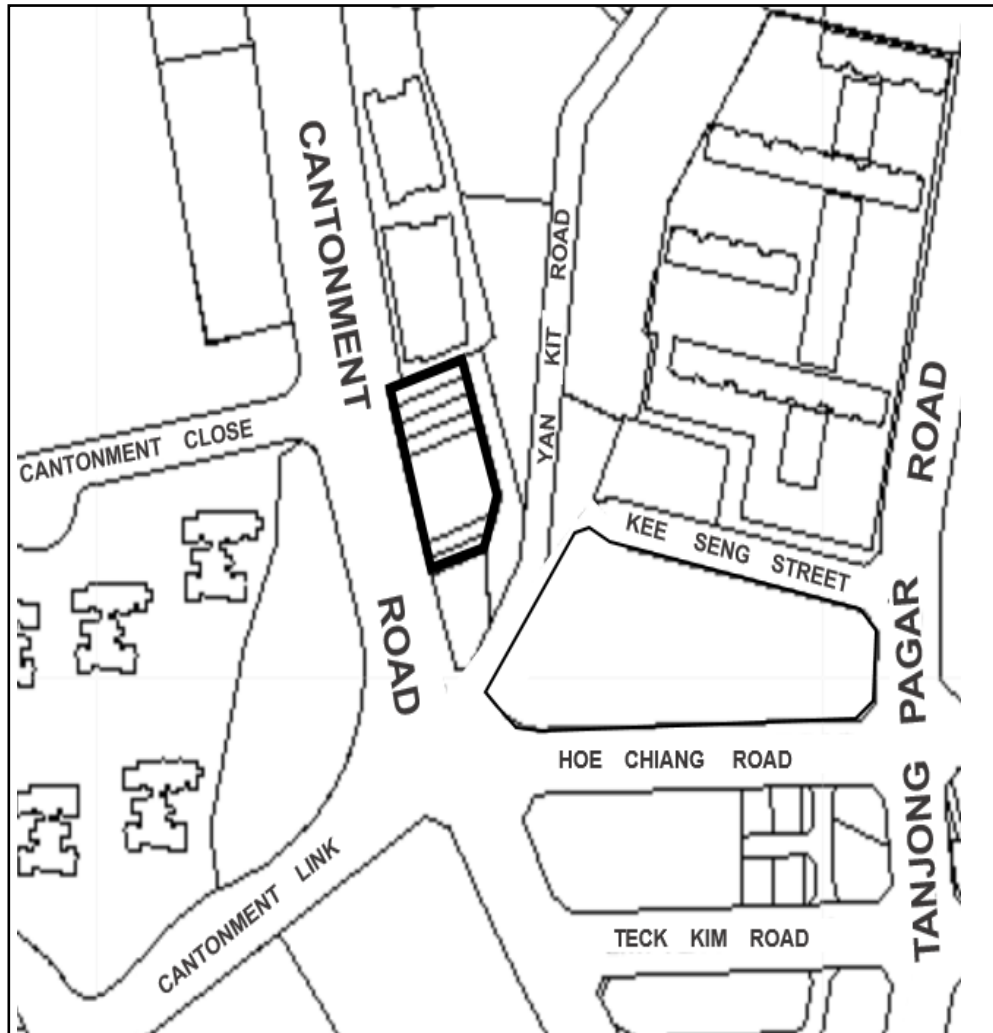

9. House numbers 65 and 69 at Mohamed Sultan Road, and which are more particularly delineated in Map 5.
10. House numbers 20, 22, 38 and 50 at Martin Road, and which are more particularly delineated in Map 5.
11. House number 11 at Arnasalam Chetty Road, and which is more particularly delineated in Map 5.
12. House number 9 at Muthuraman Chetty Road, and which is more particularly delineated in Map 5.

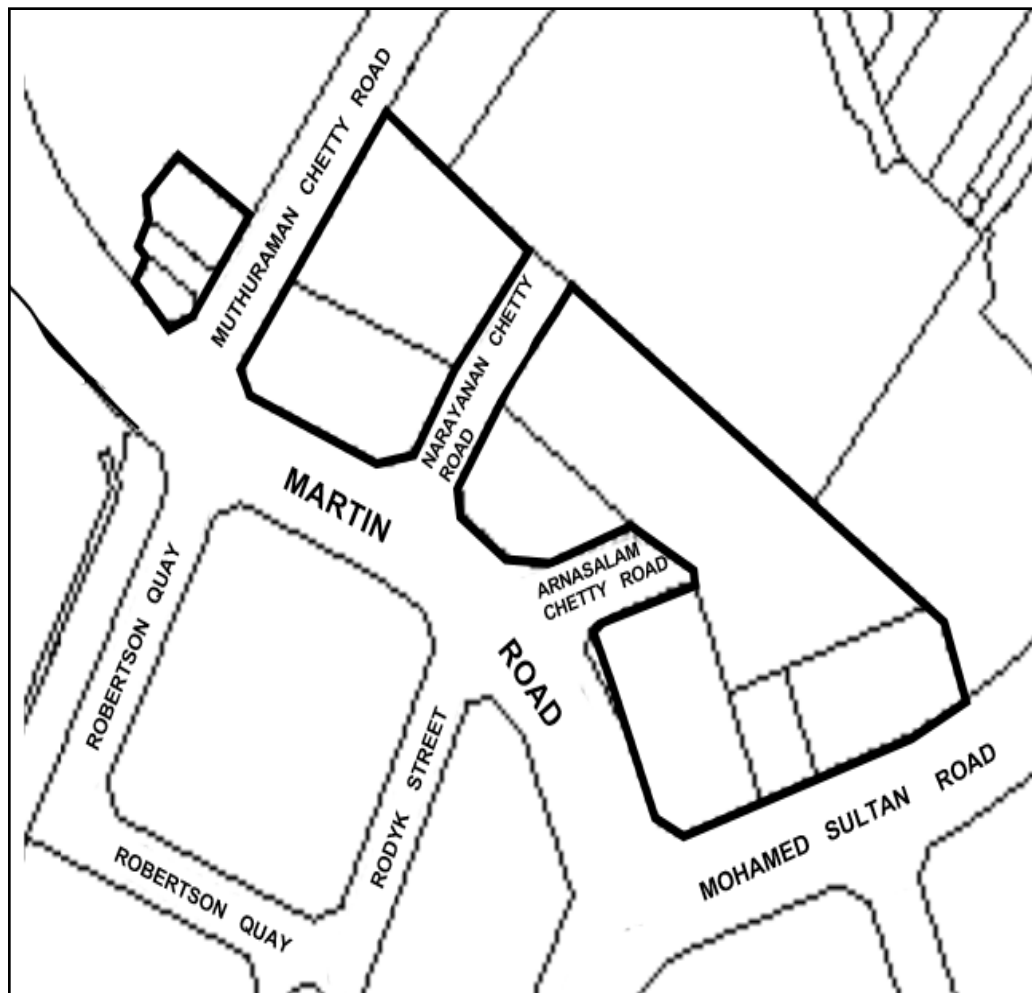
MAP 5

13. House numbers 218, 220, 224, 226, 228, 230, 232, 234, 236, 238, 240, 242, 244, 248, 262, 264, 266, 268, 270, 272, 274, 276, 278, 280, 282, 284, 286, 288, 290, 292, 294, 296, 298 and 308 at River Valley Road, and which are more particularly delineated in Map 6.
14. House numbers 1, 3 and 5 at Tank Road, and which are more particularly delineated in Map 6.

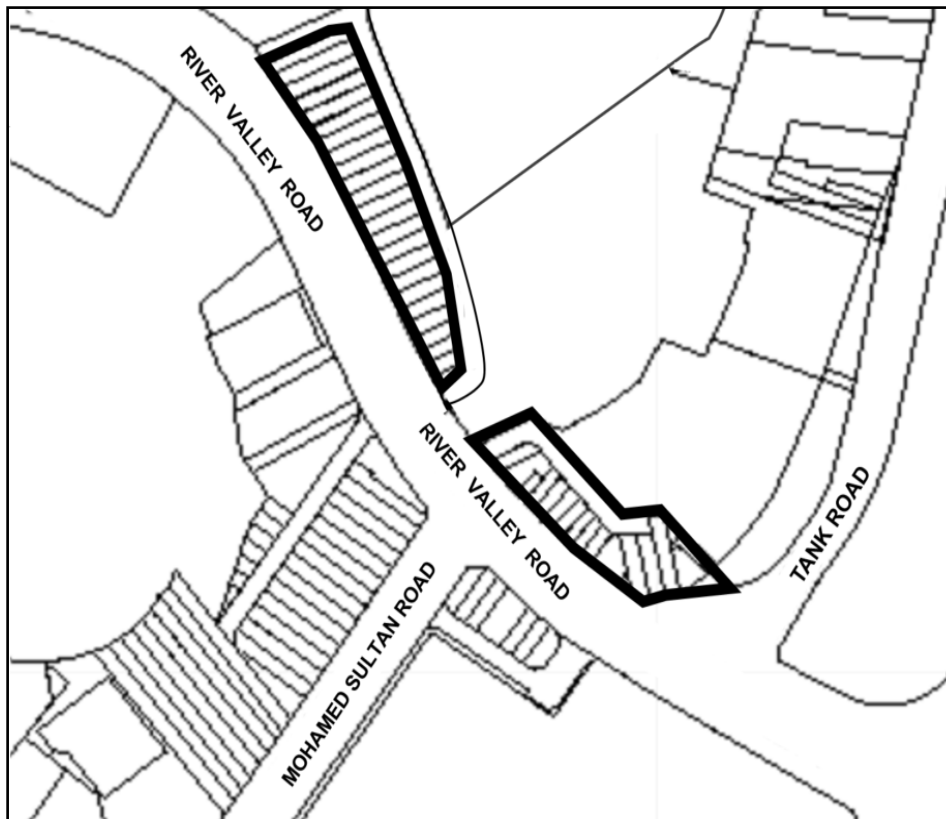
MAP 6

15. House numbers 219, 223, 225, 227, 229, 231, 233, 235, 237, 239, 241, 243, 245, 247, 249, 251, 253, 255, 257, 259, 261, 263, 265, 267, 269, 271, 273, 275 and 277 at Jalan Kayu, and which are more particularly delineated in Map 7.

MAP 7

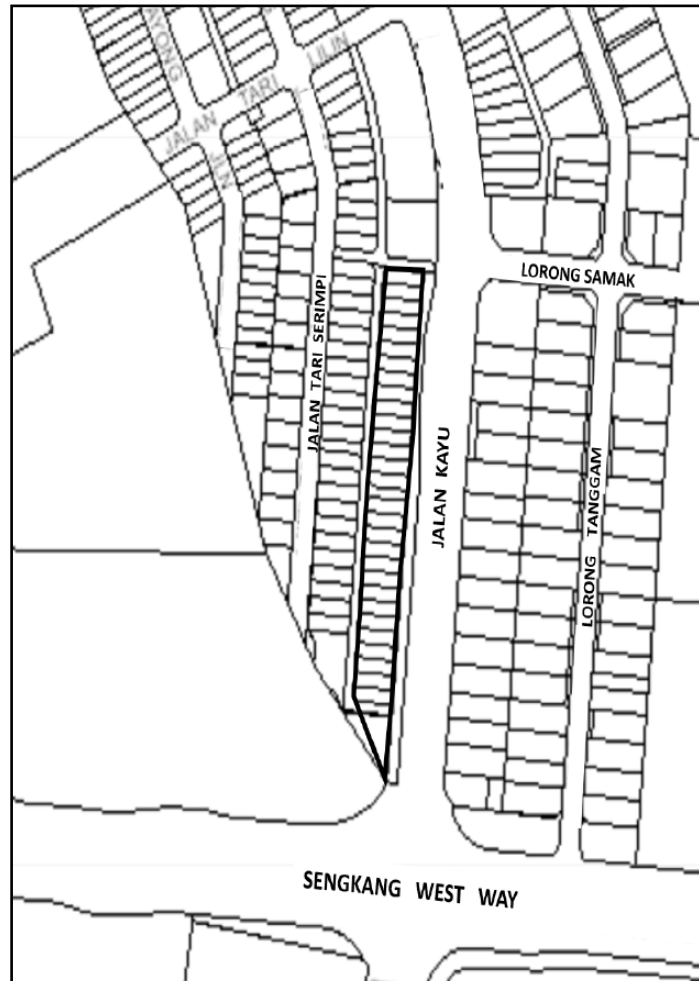

16. House numbers 242, 244, 246, 248, 250, 252, 254, 256 and 258 at Jalan Kayu, and which are more particularly delineated in Map 8.

MAP 8

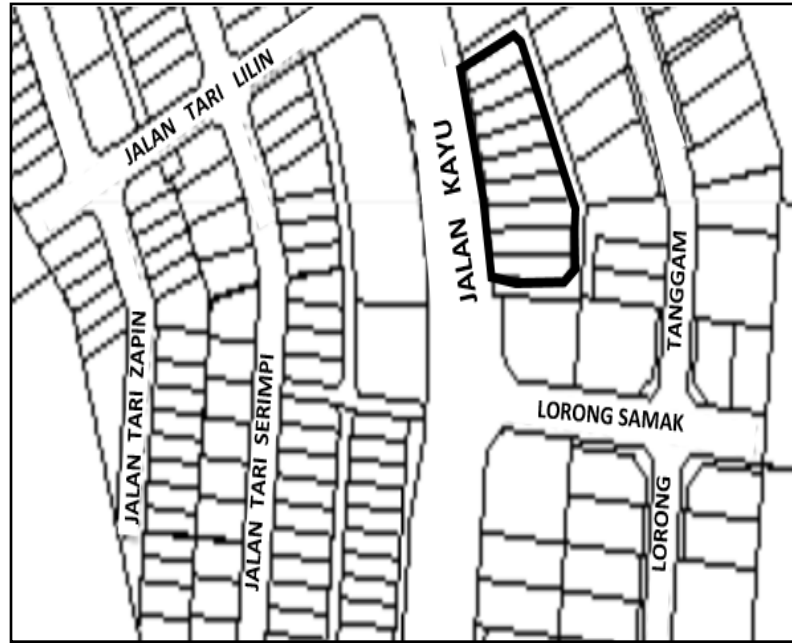

17. House numbers 2, 3, 4, 5, 6, 7, 8, 9, 10, 11, 12, 14, 16, 18, 20, 22, 24, 26 and 28 at Maju Avenue, and which are more particularly delineated in Map 9.
18. House numbers 1, 2, 3, 4, 5, 6, 7, 8, 9, 10, 11, 12, 14, 14B and 14D at Kensington Park Road, and which are more particularly delineated in Map 9.
19. House numbers 53, 55, 56, 57, 58, 59, 60, 61, 62, 63, 64, 65, 66, 67, 68, 69, 70, 71, 73, 75, 77, 79, 81, 83, 85 and 87 at Serangoon Garden Way, and which are more particularly delineated in Map 9.

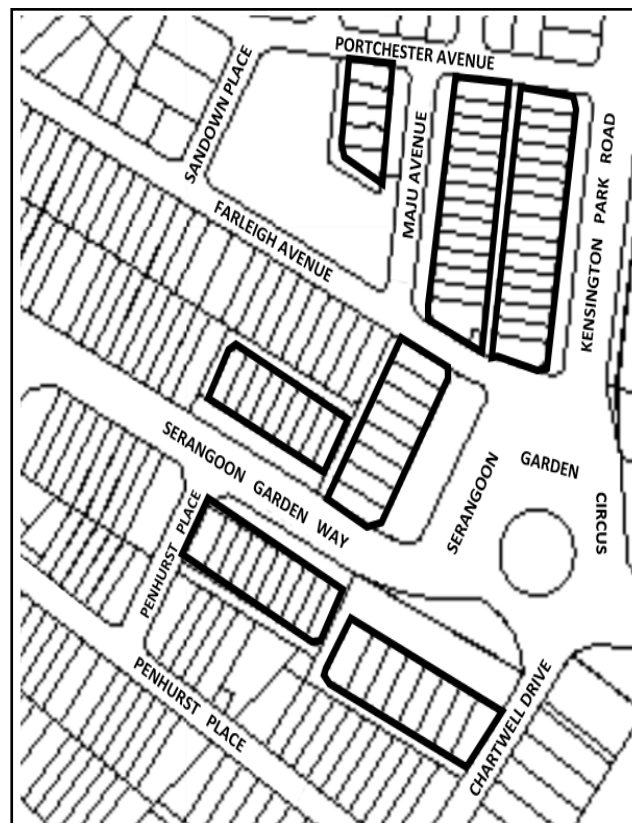
MAP 9

20. House numbers 219, 221, 223, 225, 227, 229, 231 and 233 at River Valley Road, and which are more particularly delineated in Map 10.

MAP 10

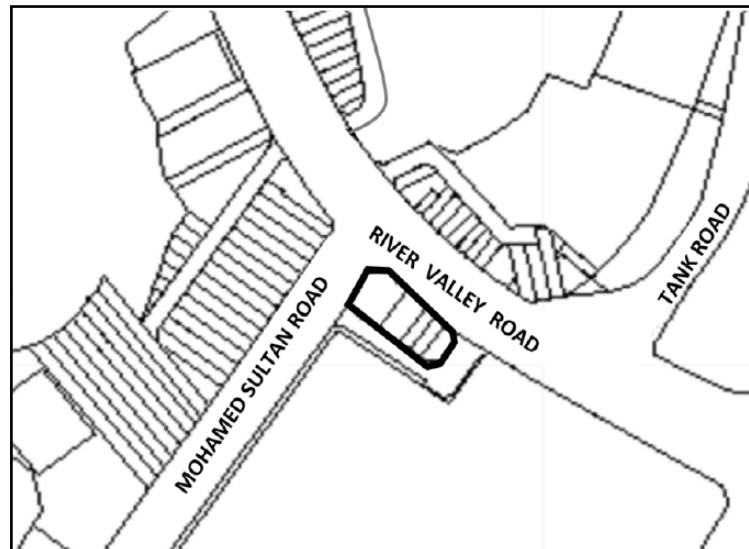

21. House numbers 1, 2, 3, 4, 5, 6, 7, 8, 9, 10, 11, 12, 13, 14, 15, 16 and 17 at Upper Circular Road, and which are more particularly delineated in Map 11.
22. House numbers 13, 15, 16, 17, 18, 19, 29, 30, 31, 32, 33, 36, 37, 39, 40, 41, 42 and 43 at Carpenter Street, and which are more particularly delineated in Map 11.
23. House numbers 5, 6, 7, 8, 9, 10, 11, 12, 13, 15, 17, 18, 19, 20, 21, 22, 27, 28, 29, 30, 31, 32, 33, 35, 36, 37, 38, 39, 40, 41, 42, 43, 45, 46 and 47 at Hong Kong Street, and which are more particularly delineated in Map 11.
24. House numbers 28, 30, 31, 32, 33, 34, 35, 36, 37, 38, 39, 40, 41, 42, 43, 44, 45, 46, 47 and 50 at North Canal Road, and which are more particularly delineated in Map 11.
25. House numbers 11, 13, 15, 17, 19, 21, 23, 25, 27, 35, 43, 45, 47, 49, 53, 55, 59 and 61 at New Bridge Road, and which are more particularly delineated in Map 11.
26. House numbers 32, 34, 36, 38, 40, 42, 46, 50, 54, 56, 58, 60, 62, 64, 66, 68, 70, 72, 74, 76, 78, 80, 82, 84, 86 and 88 at South Bridge Road, and which are more particularly delineated in Map 11.

MAP 11





National Parks Board Headquarters
Singapore Botanic Gardens
1 Cluny Road
Singapore 259569